

Installation manual

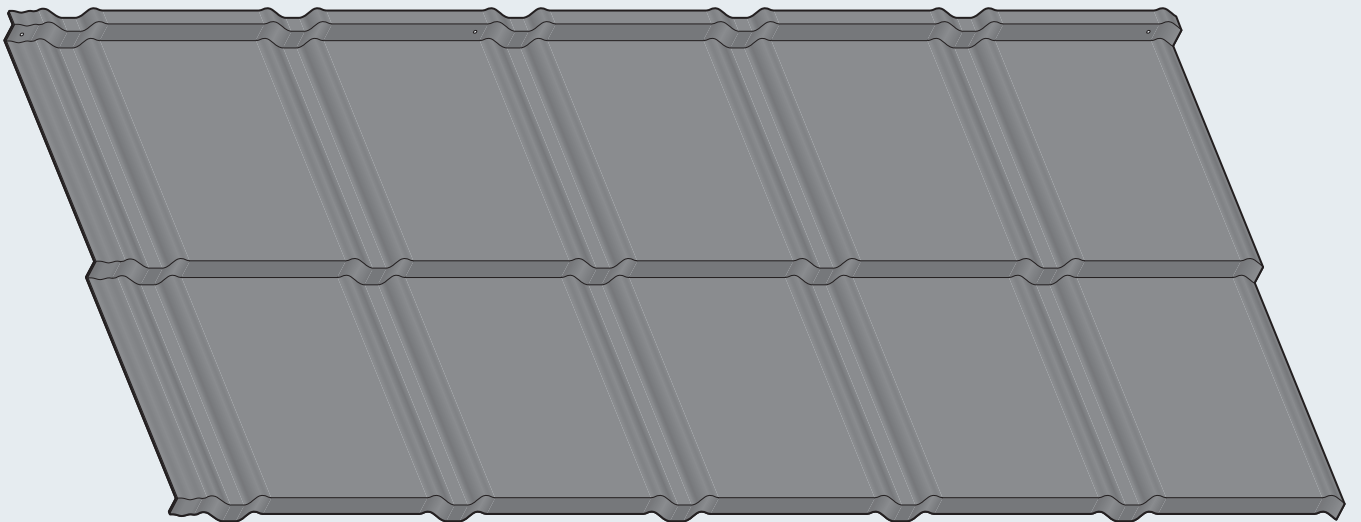

TREND

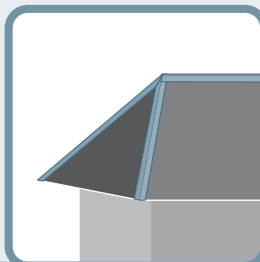

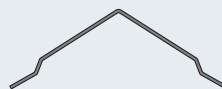
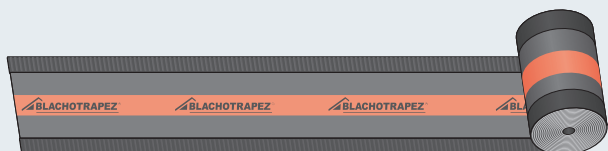
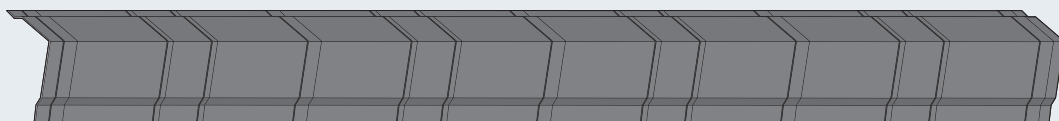
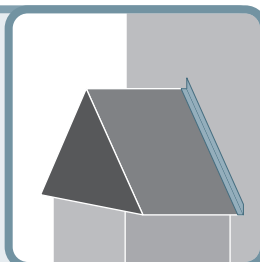
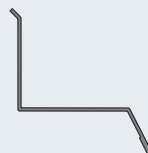
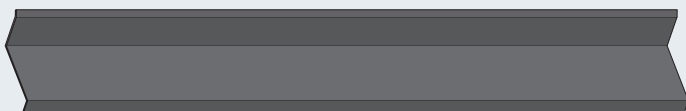
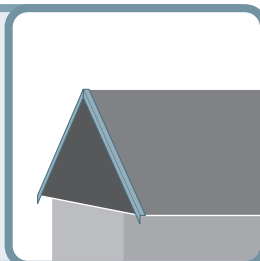
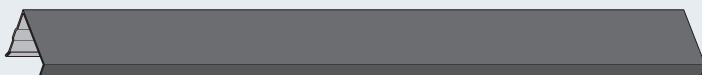
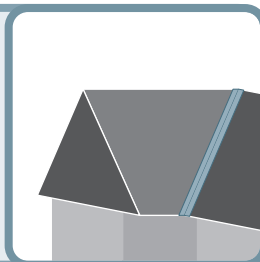
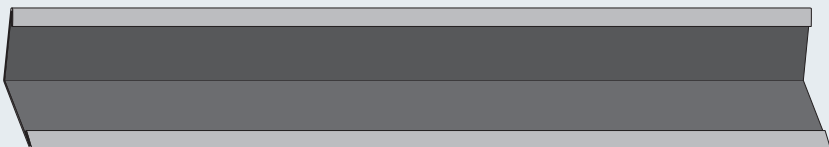
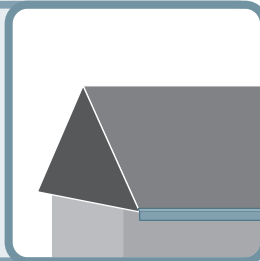
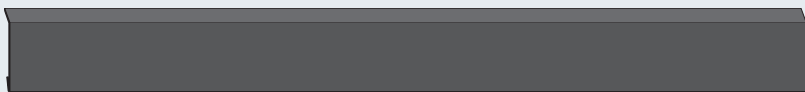
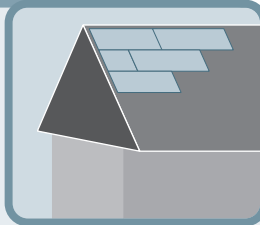
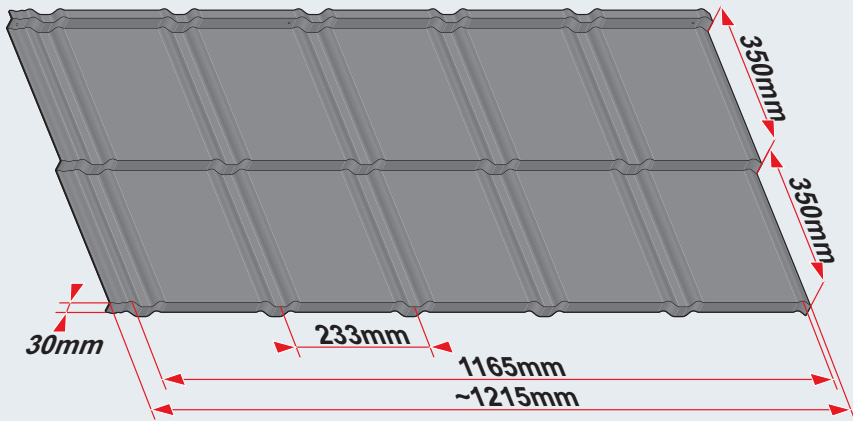

1

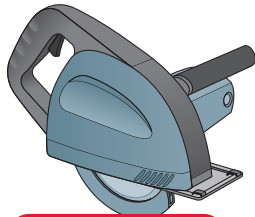
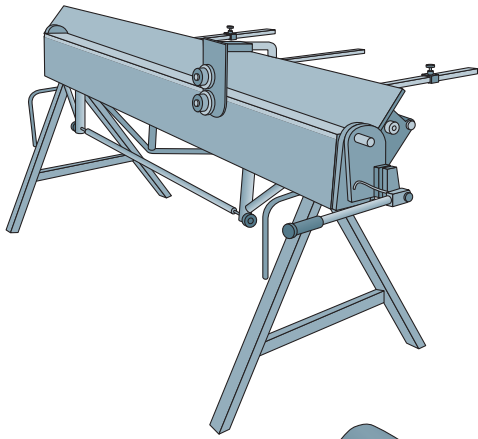

max 4000 r/min

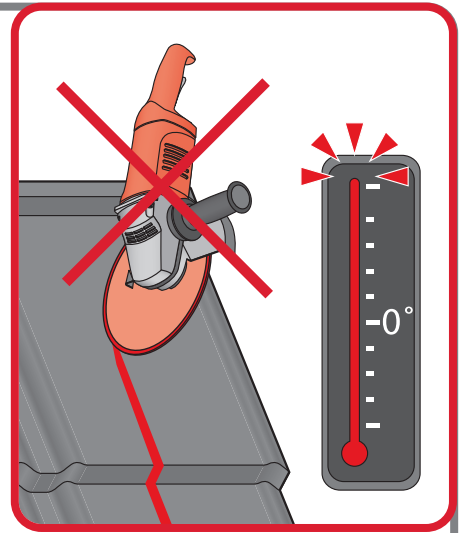
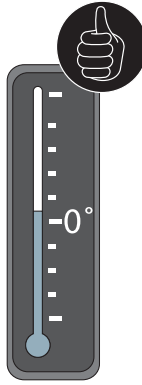
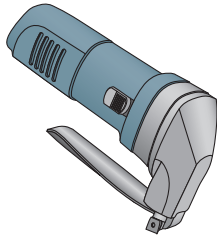

2

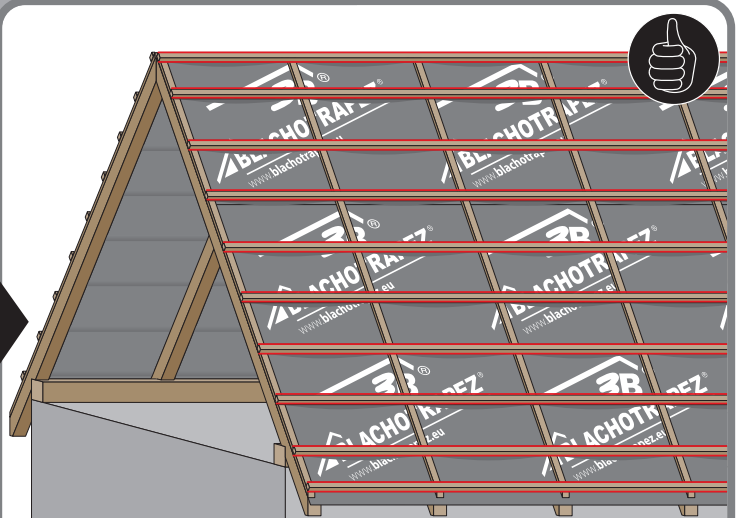
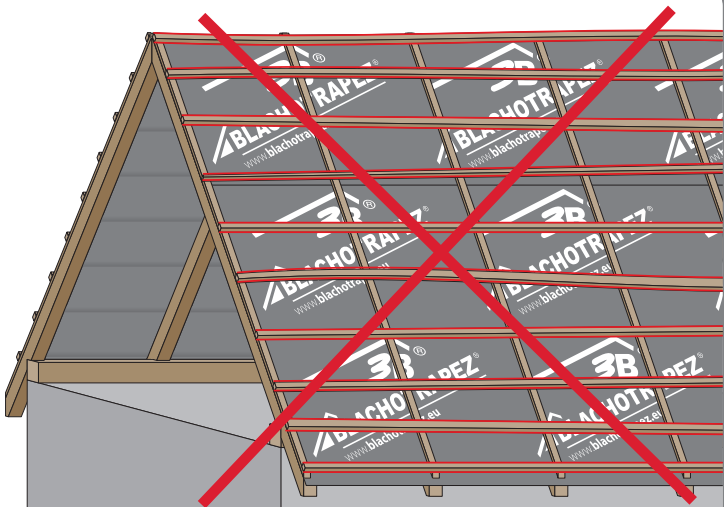
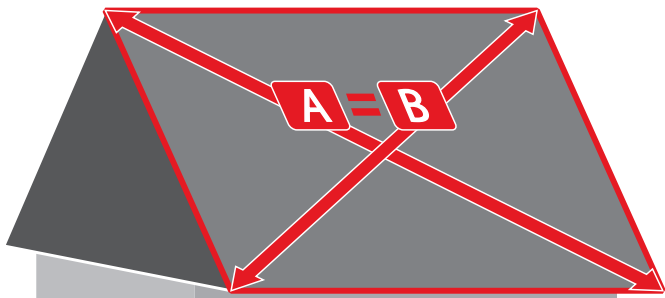

3a

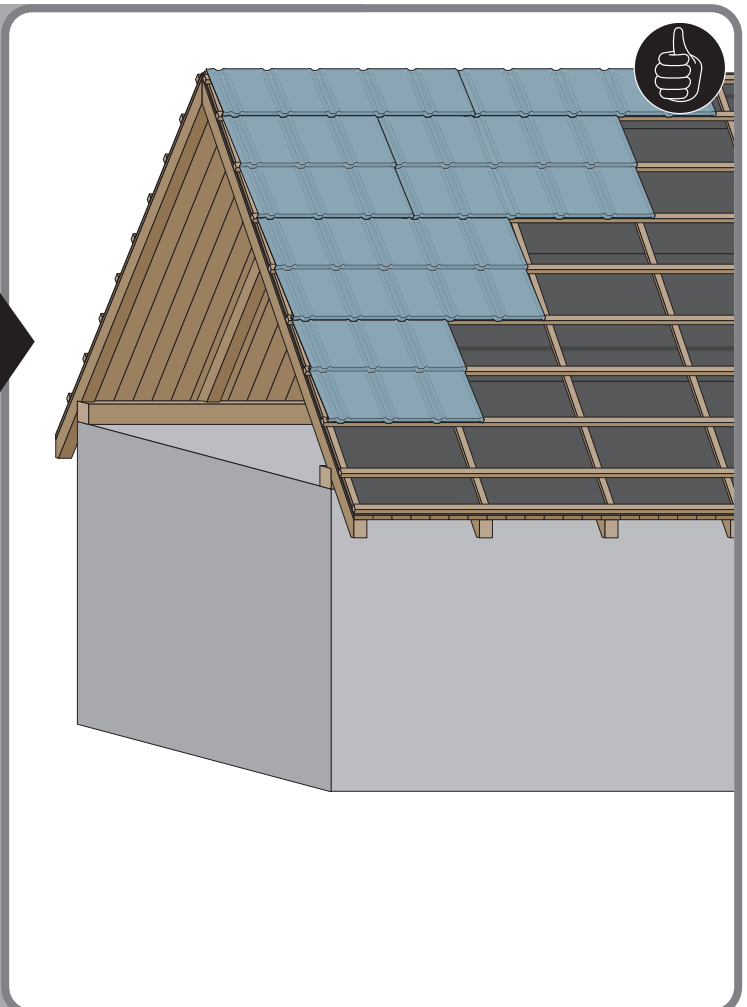
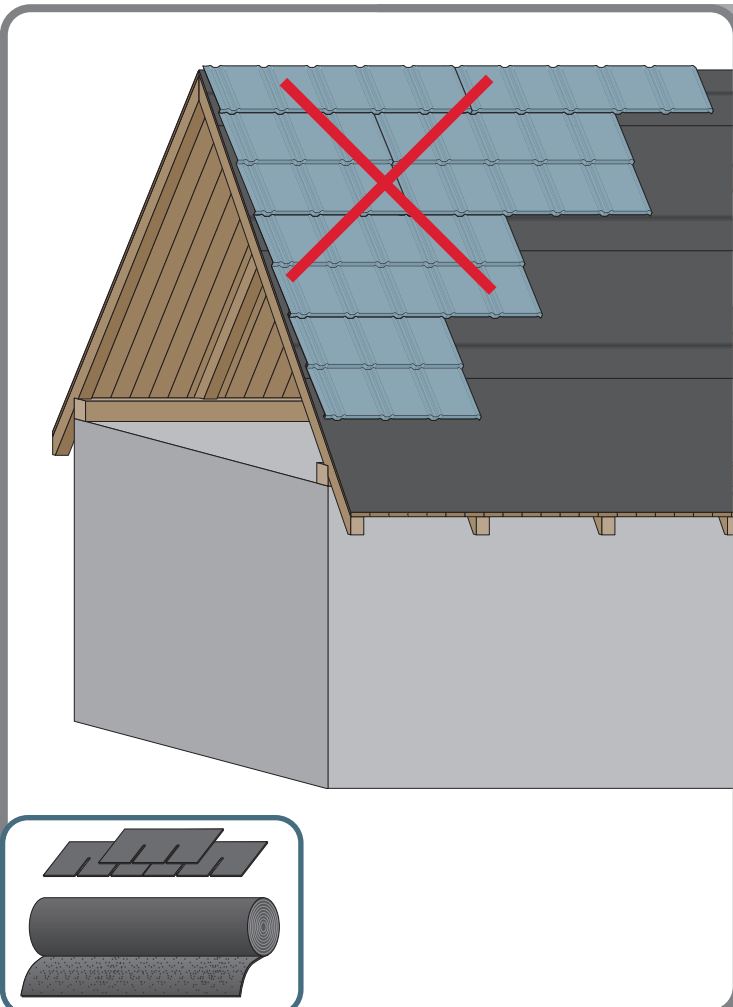
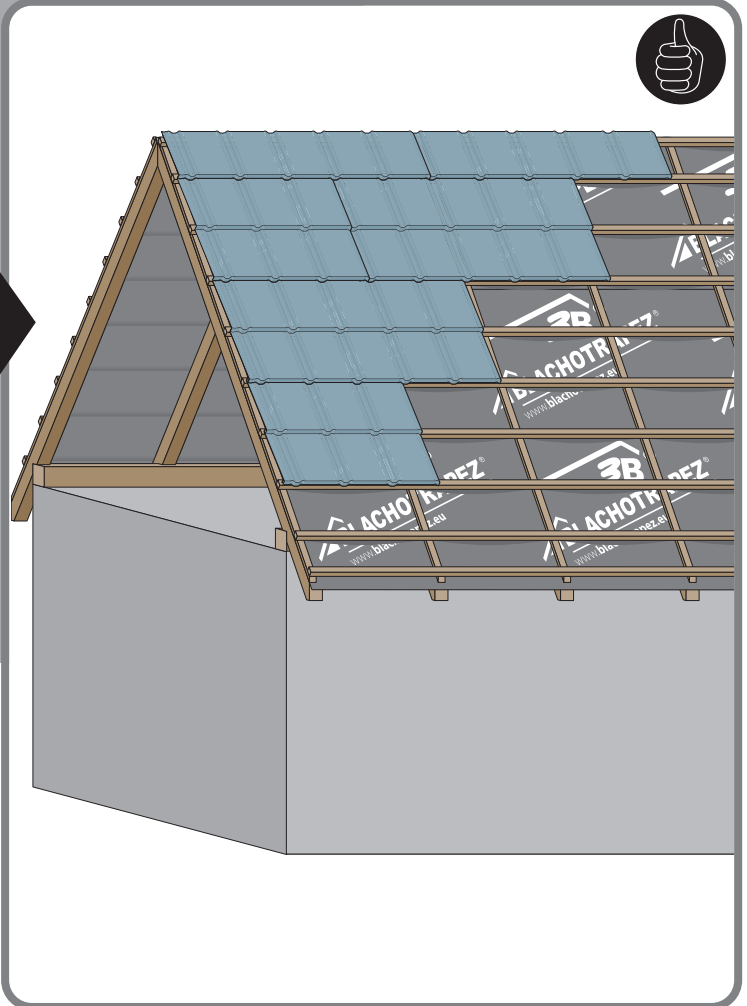
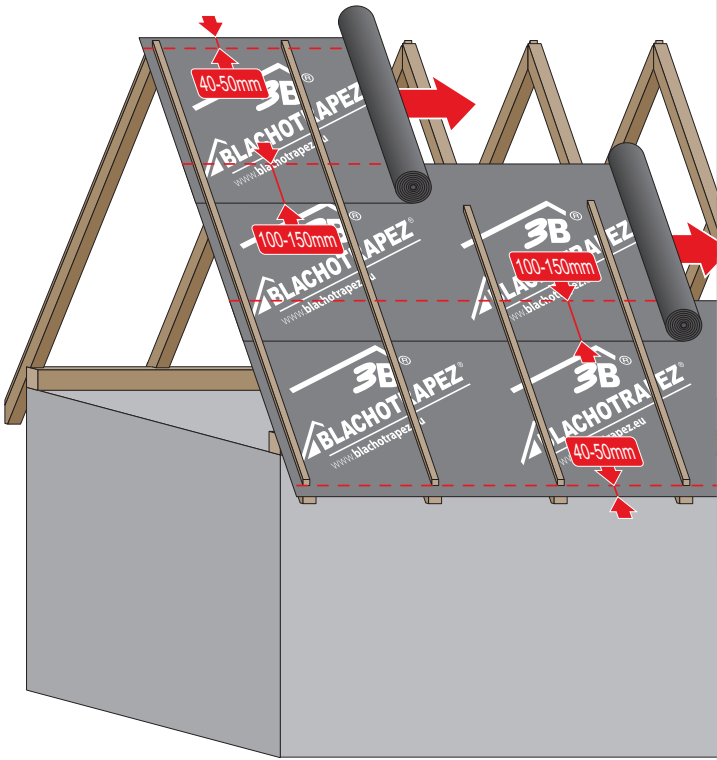

3b

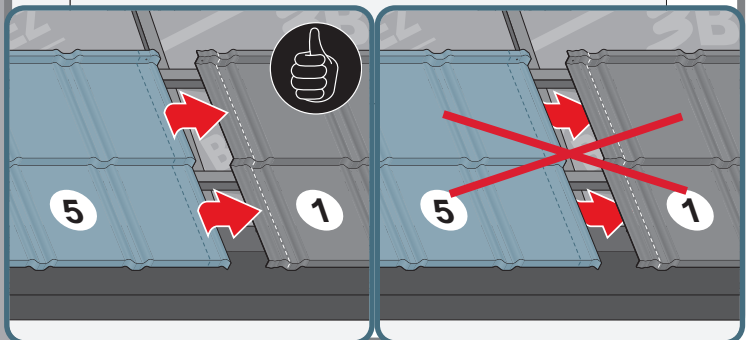
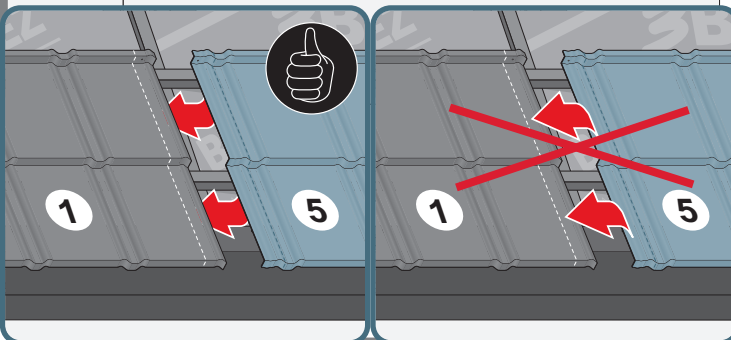
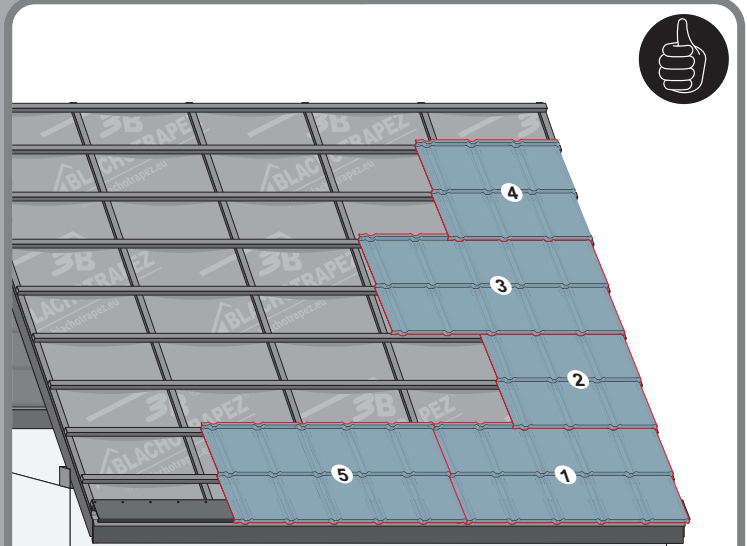
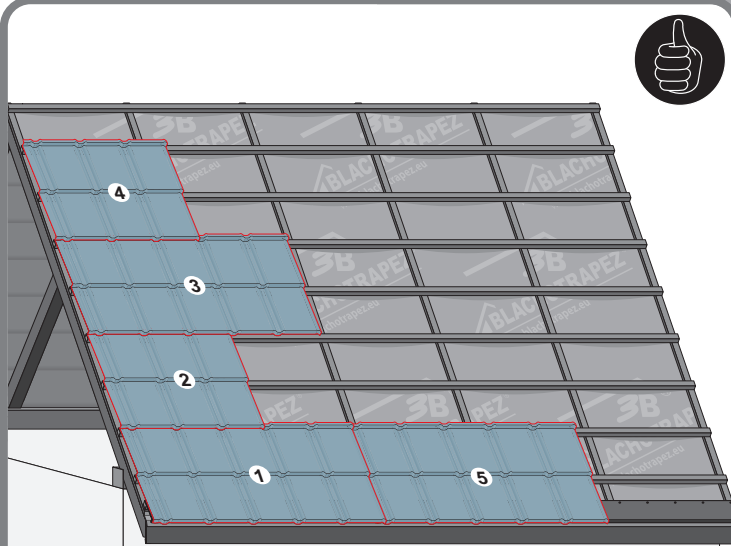
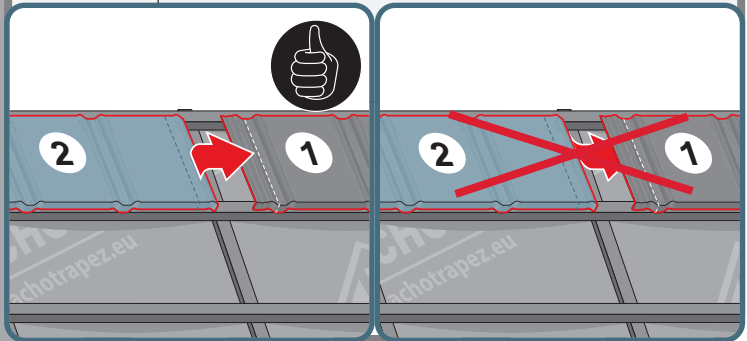
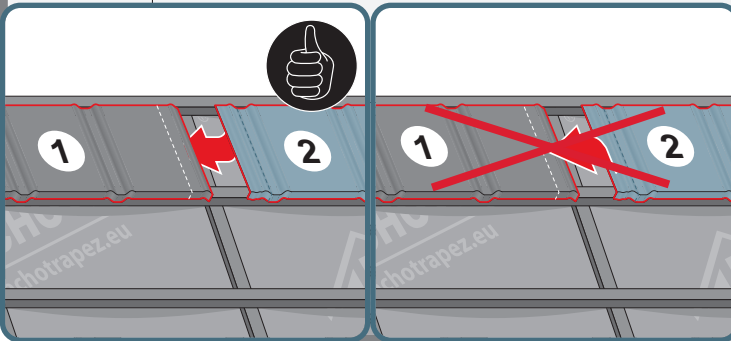
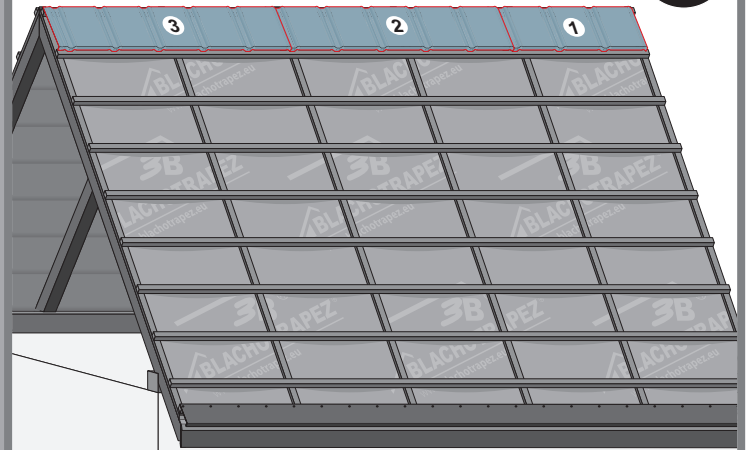
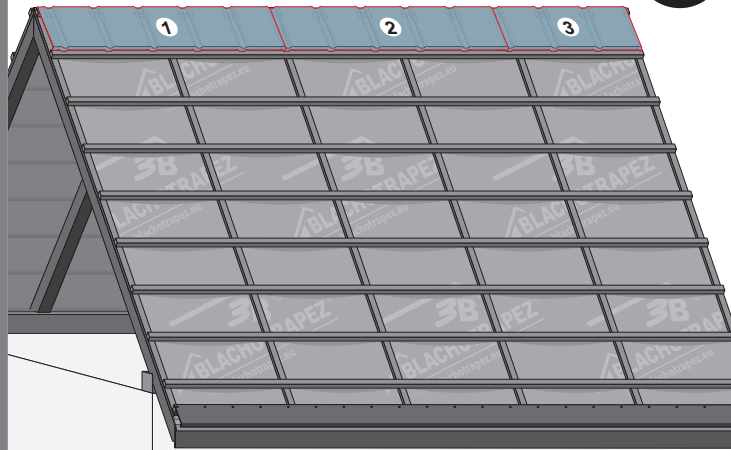

3c

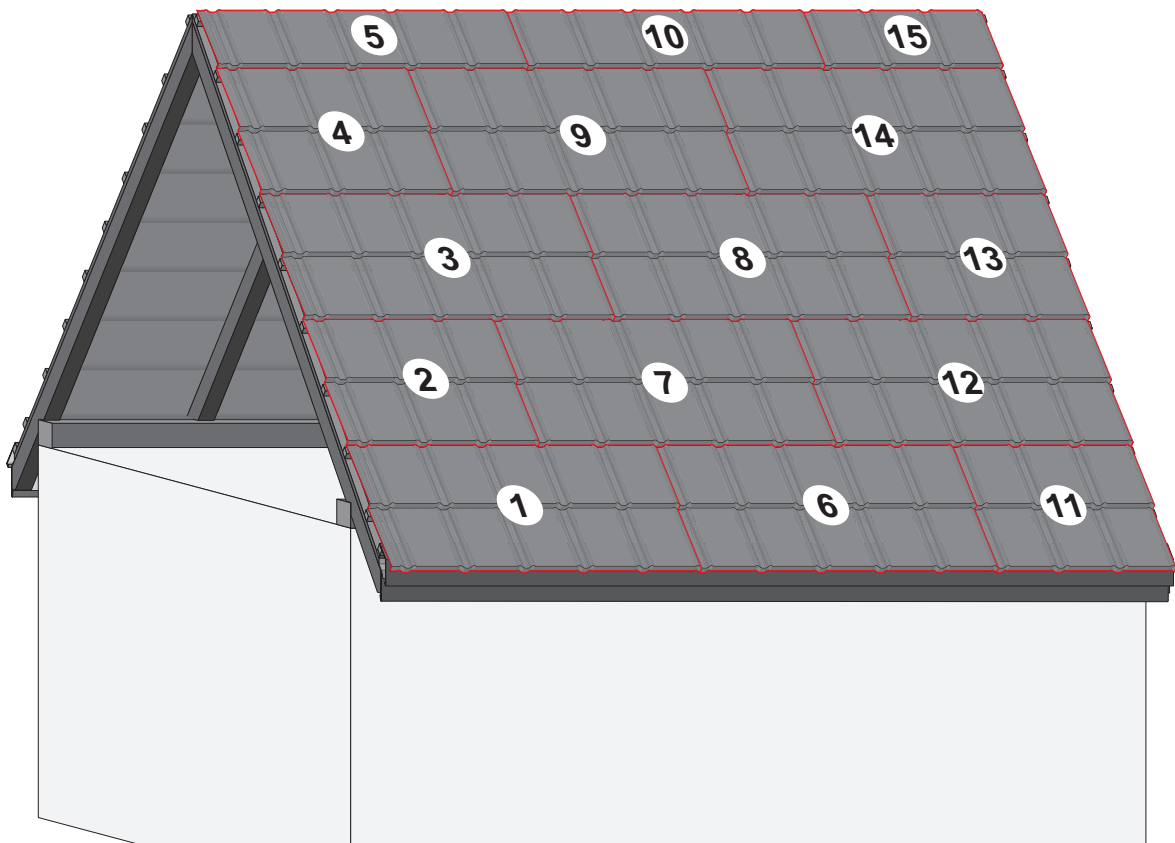
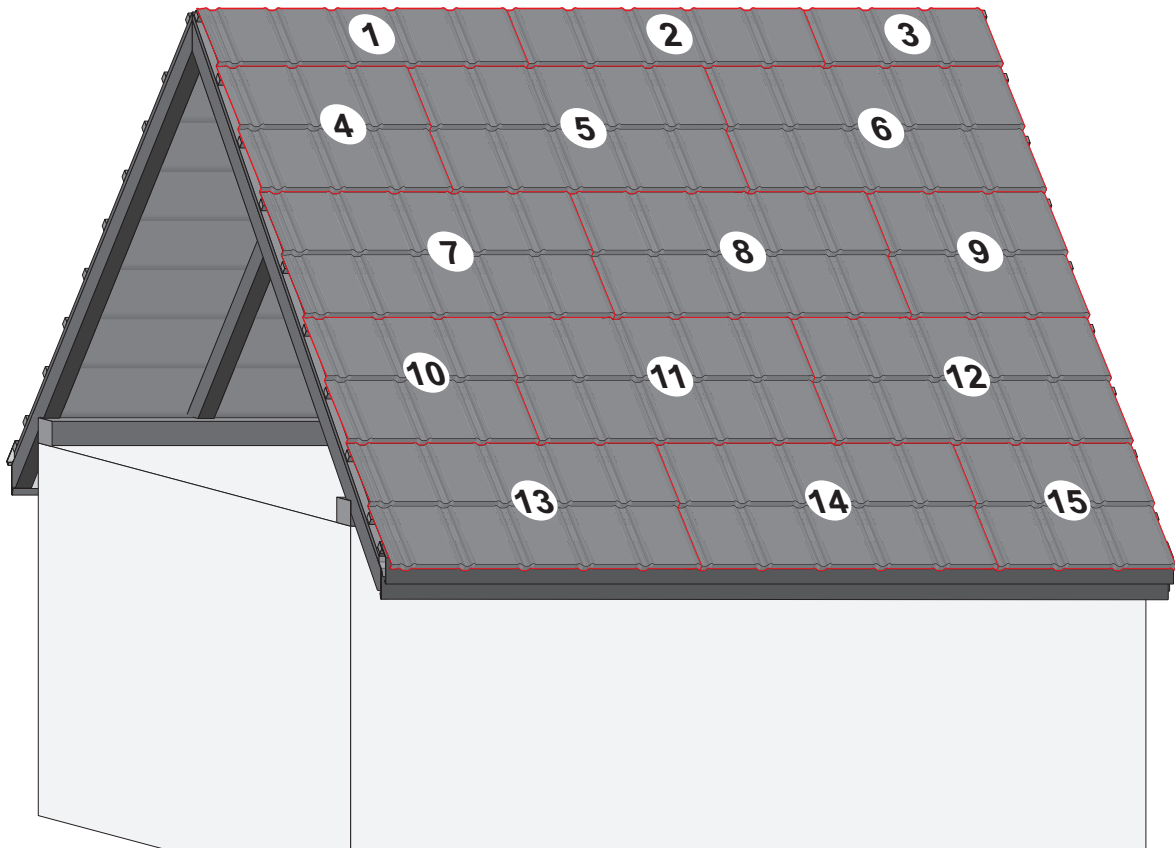

4

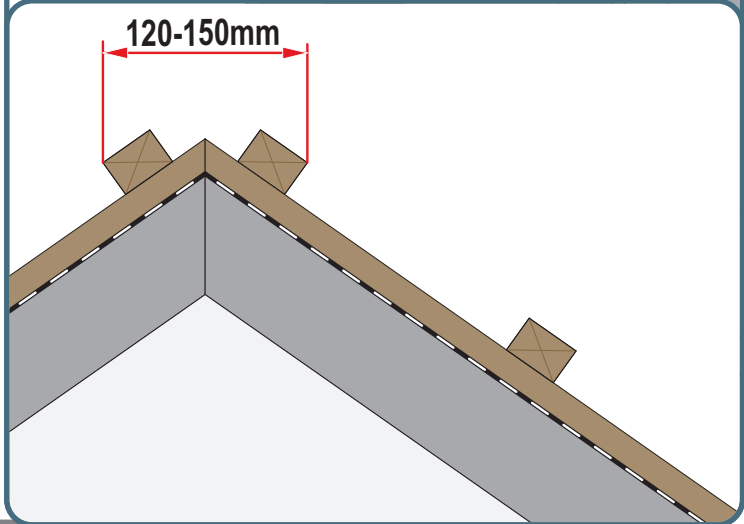
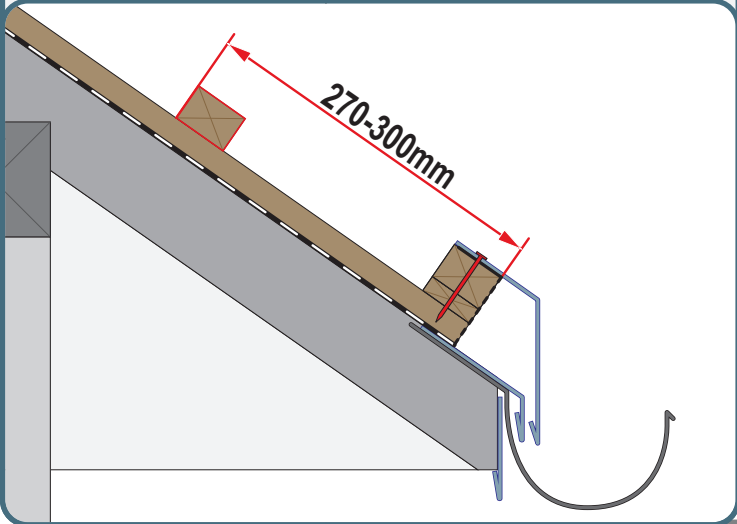
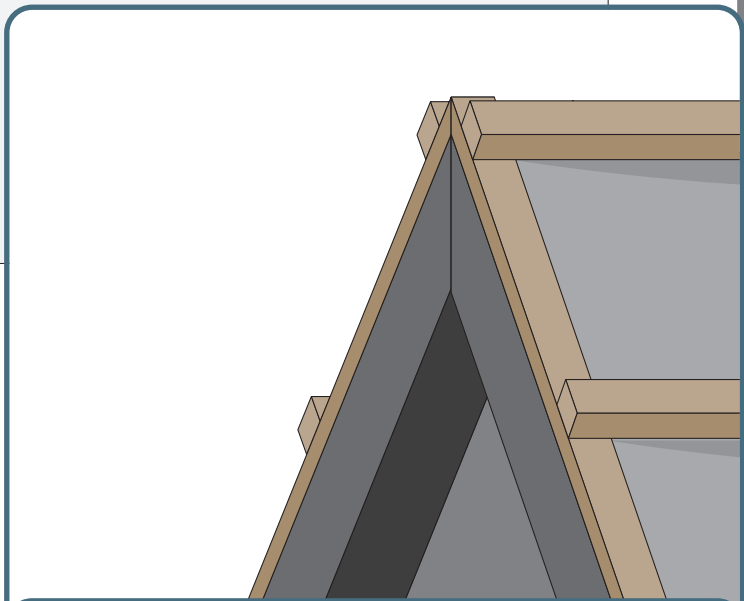
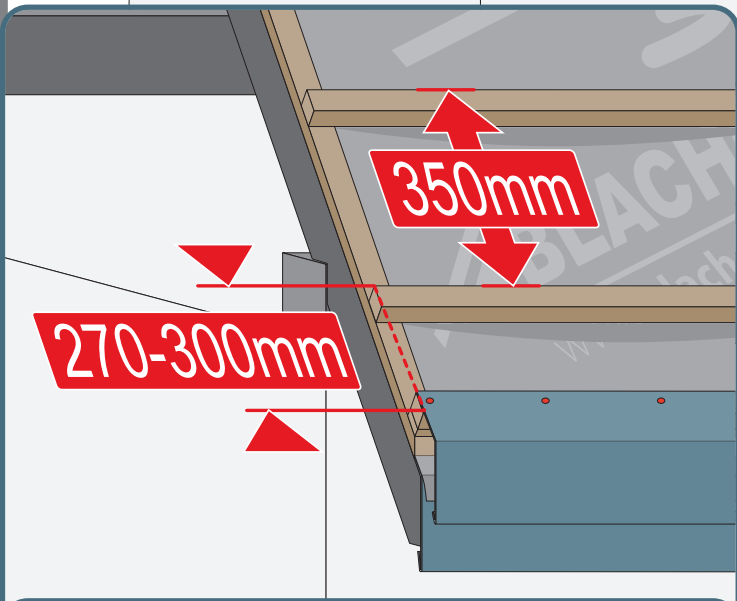
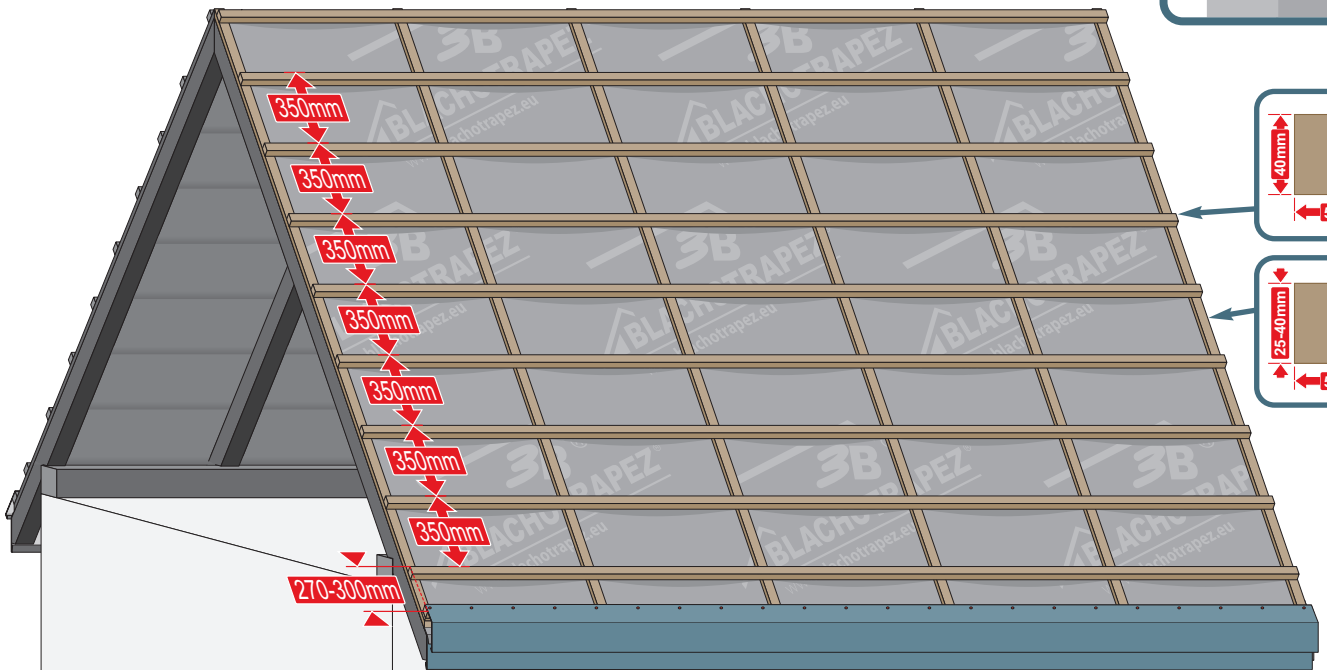

5a

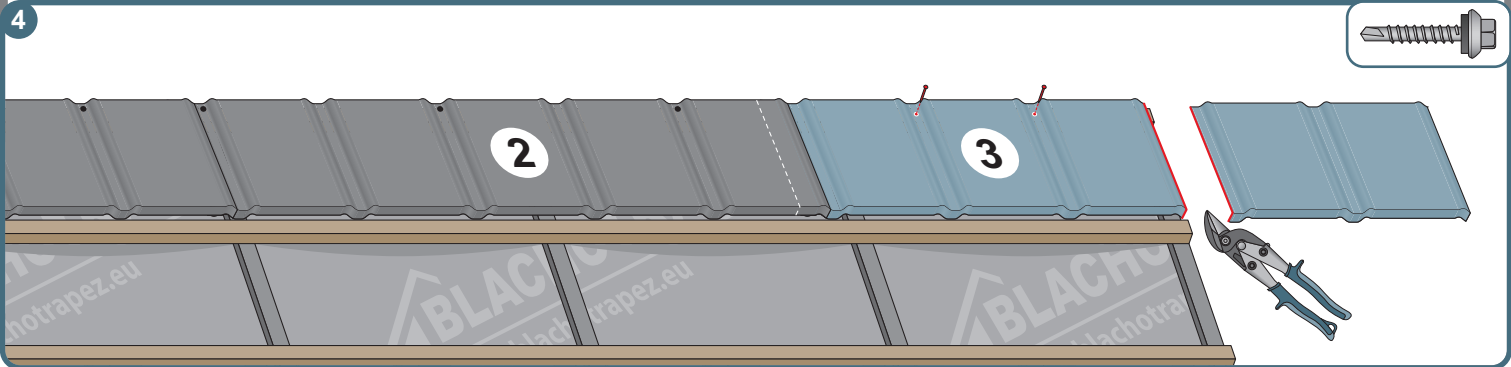
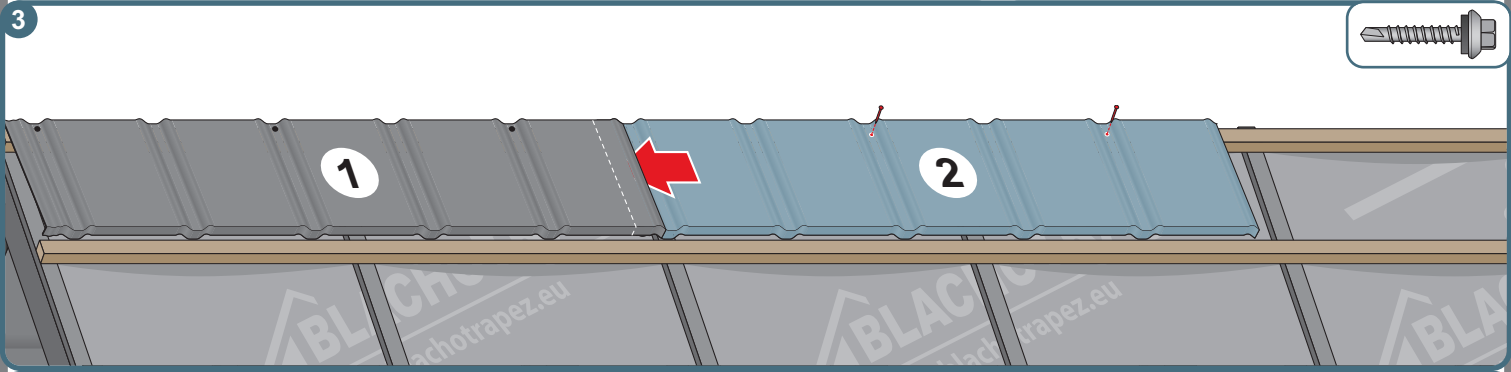
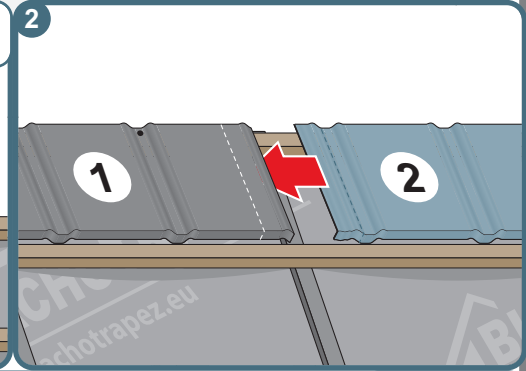
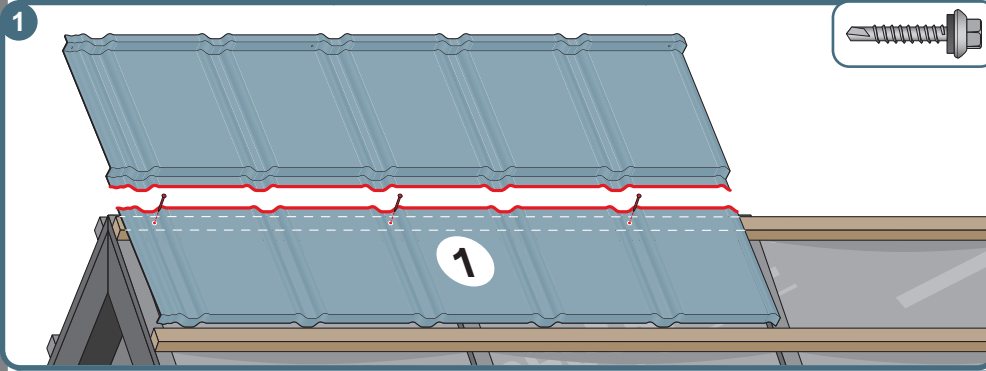
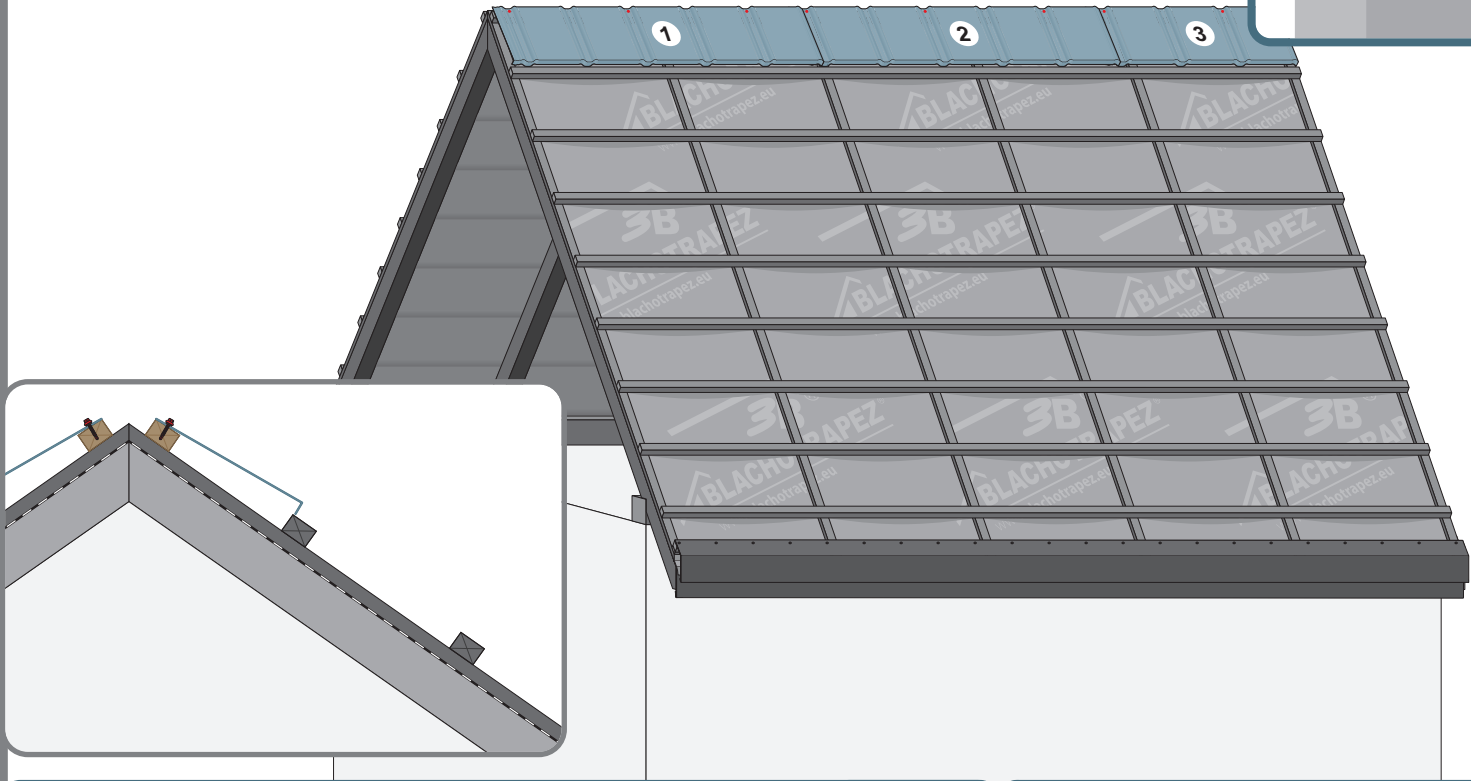
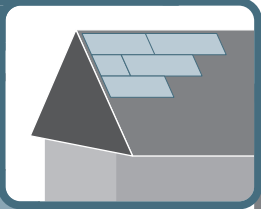

5b

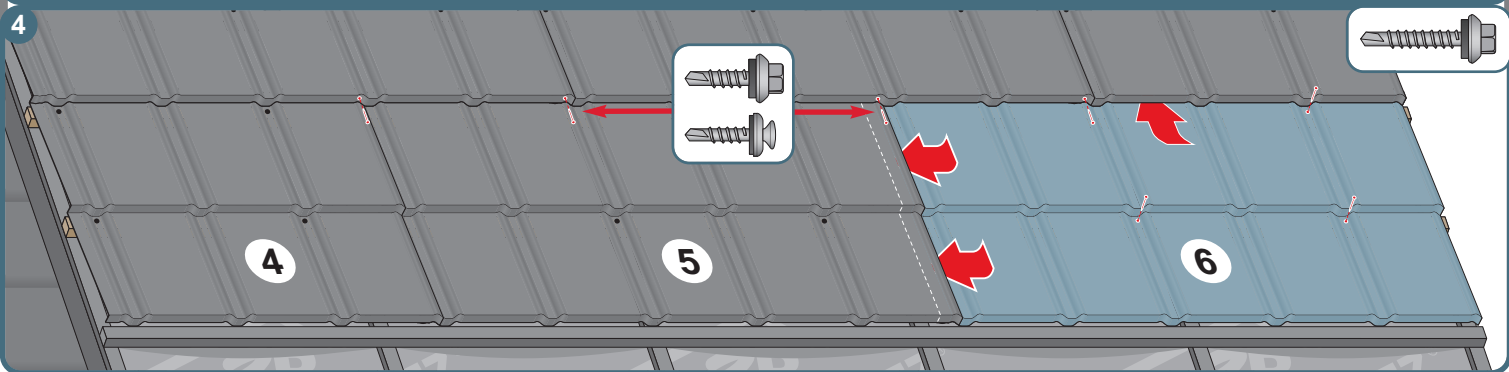
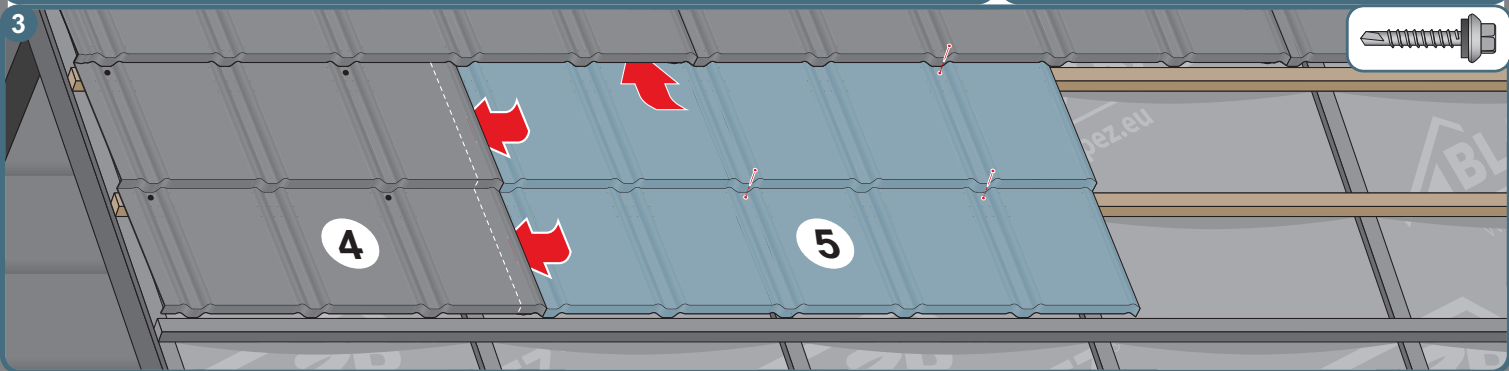
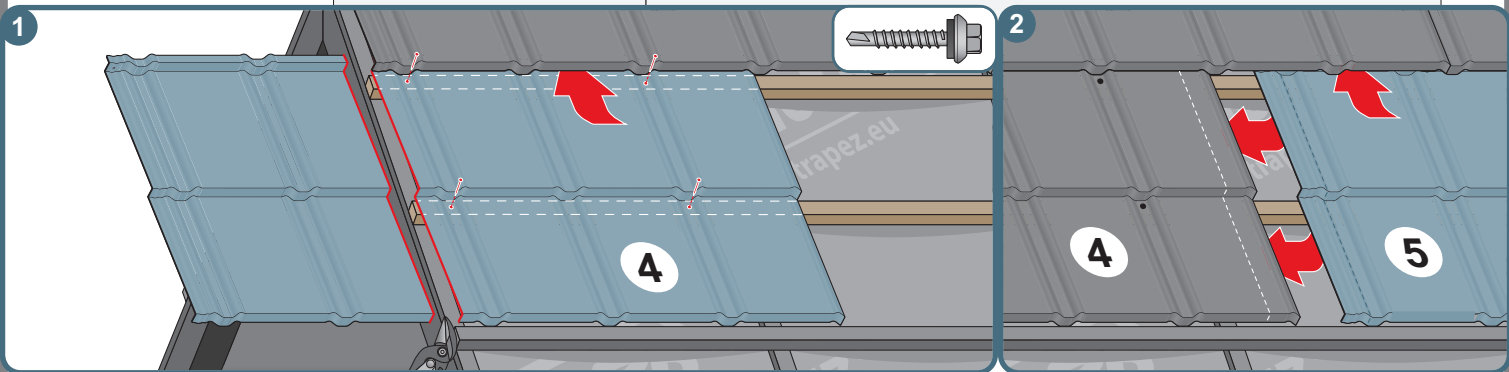
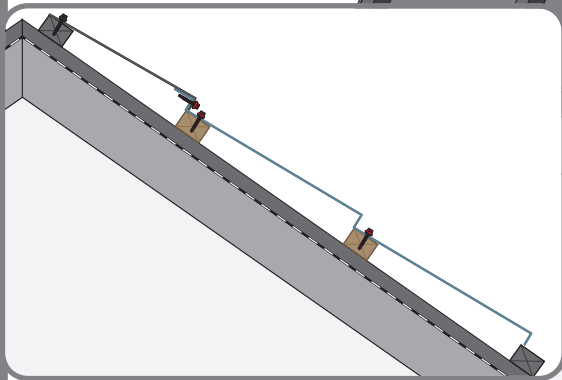
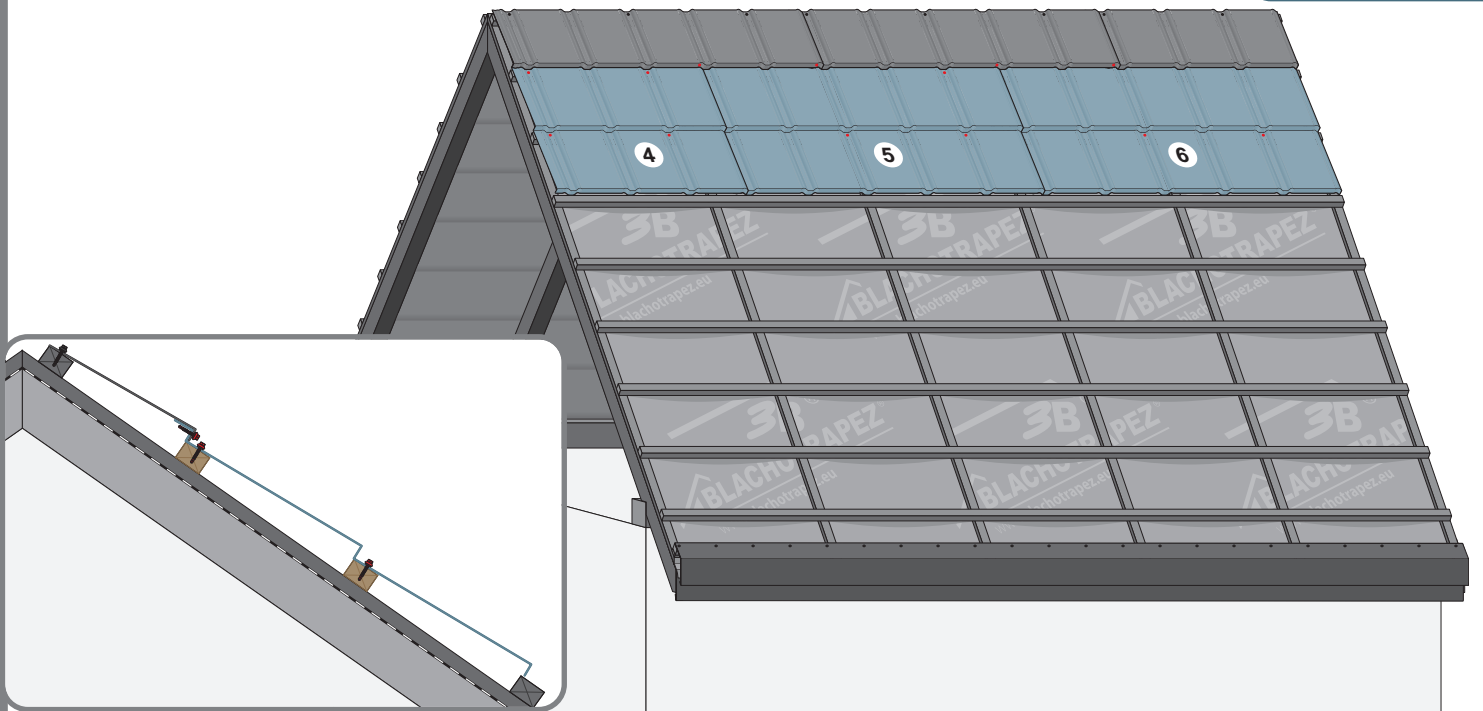
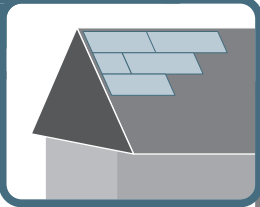

5c

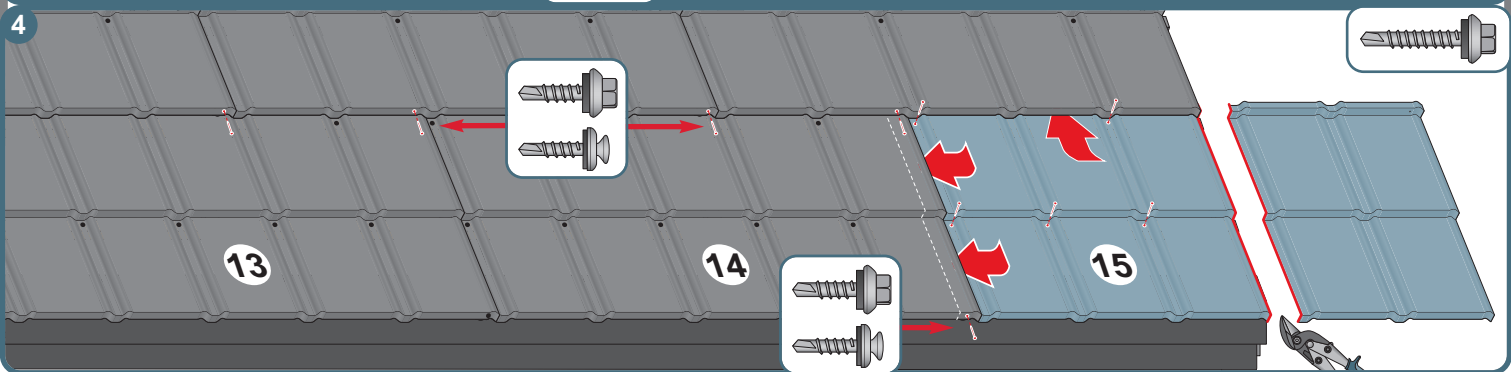
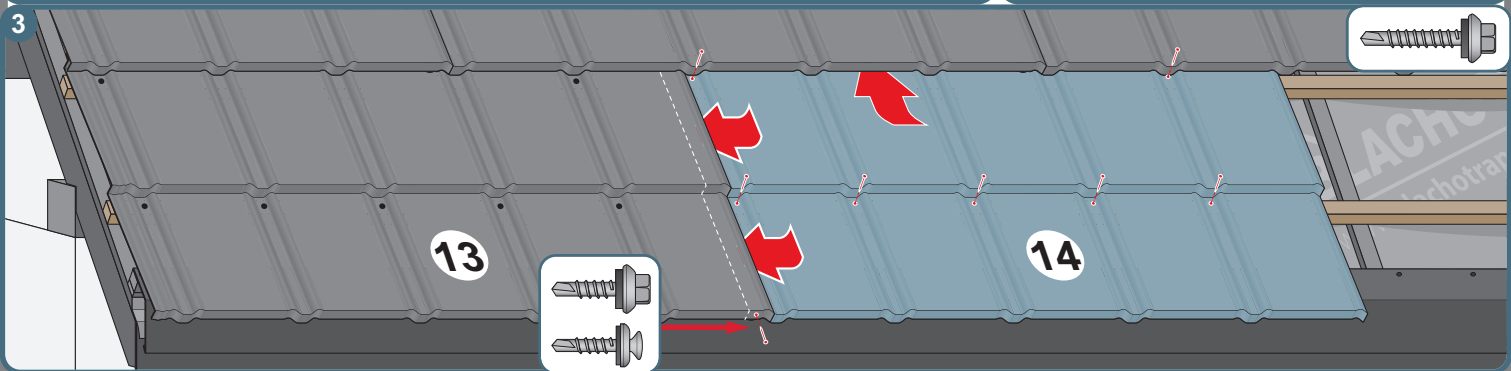
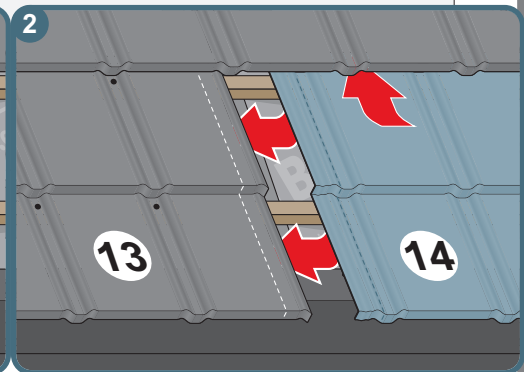
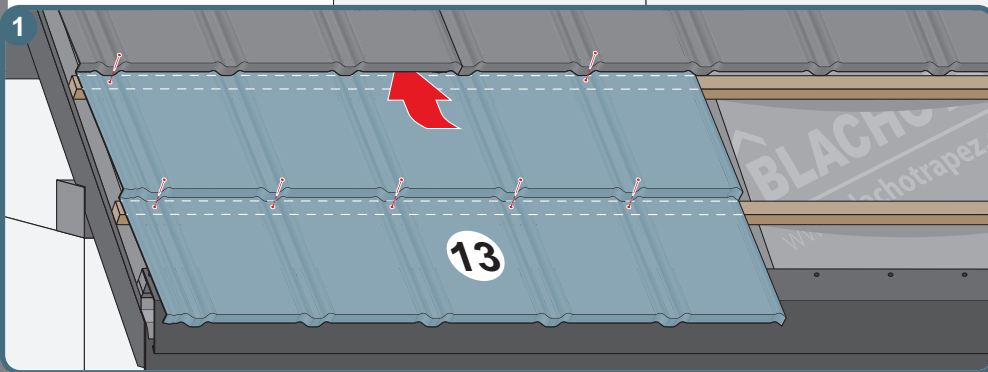
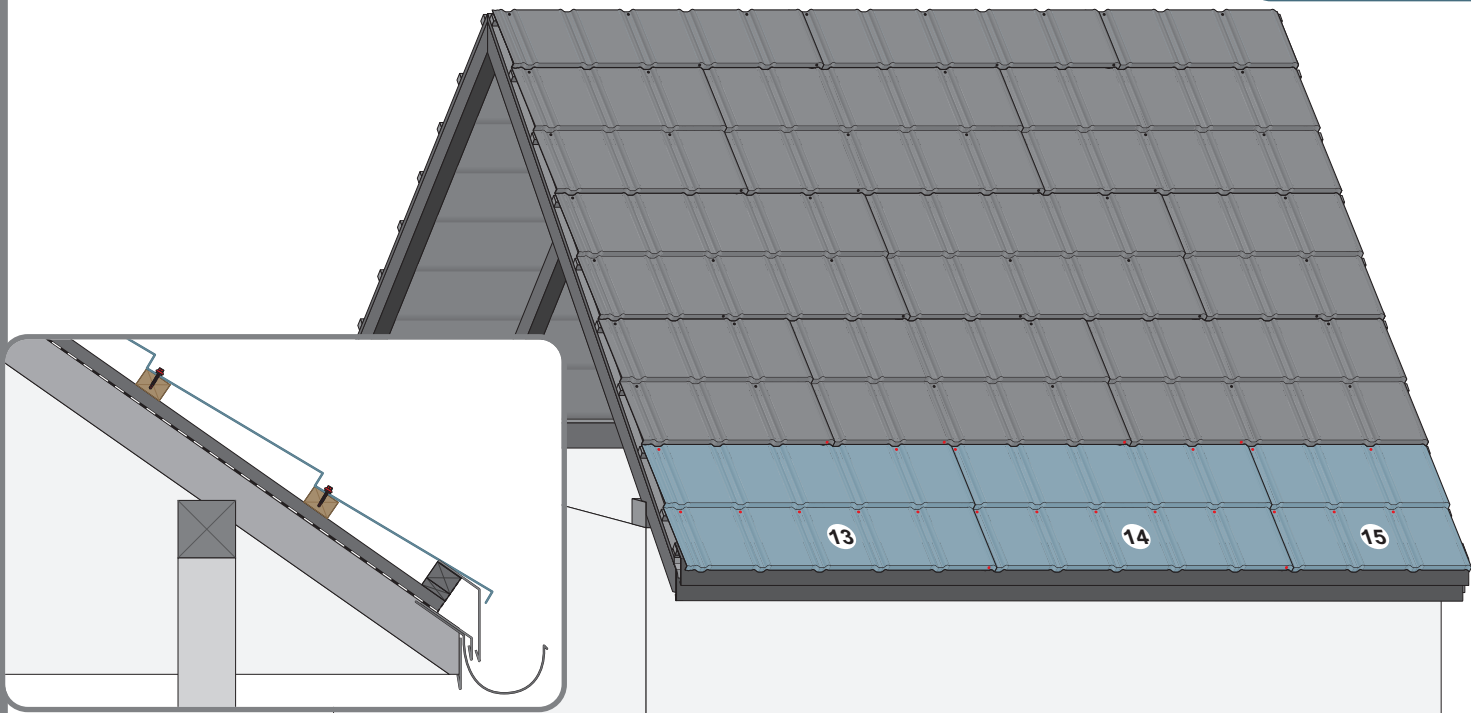
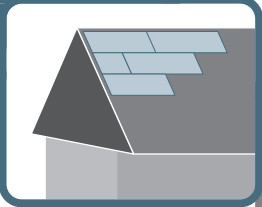

5d

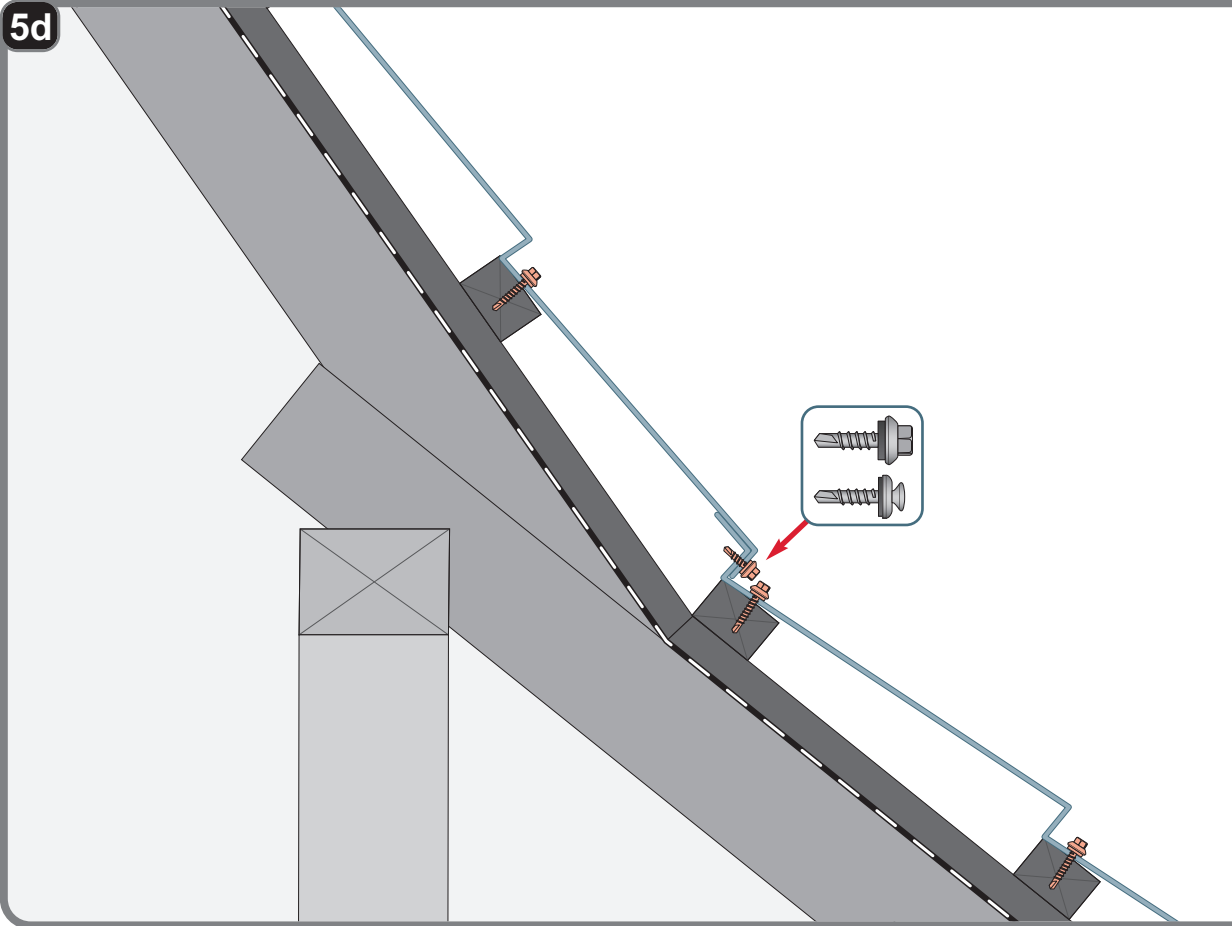
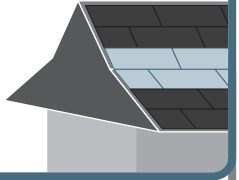

5e

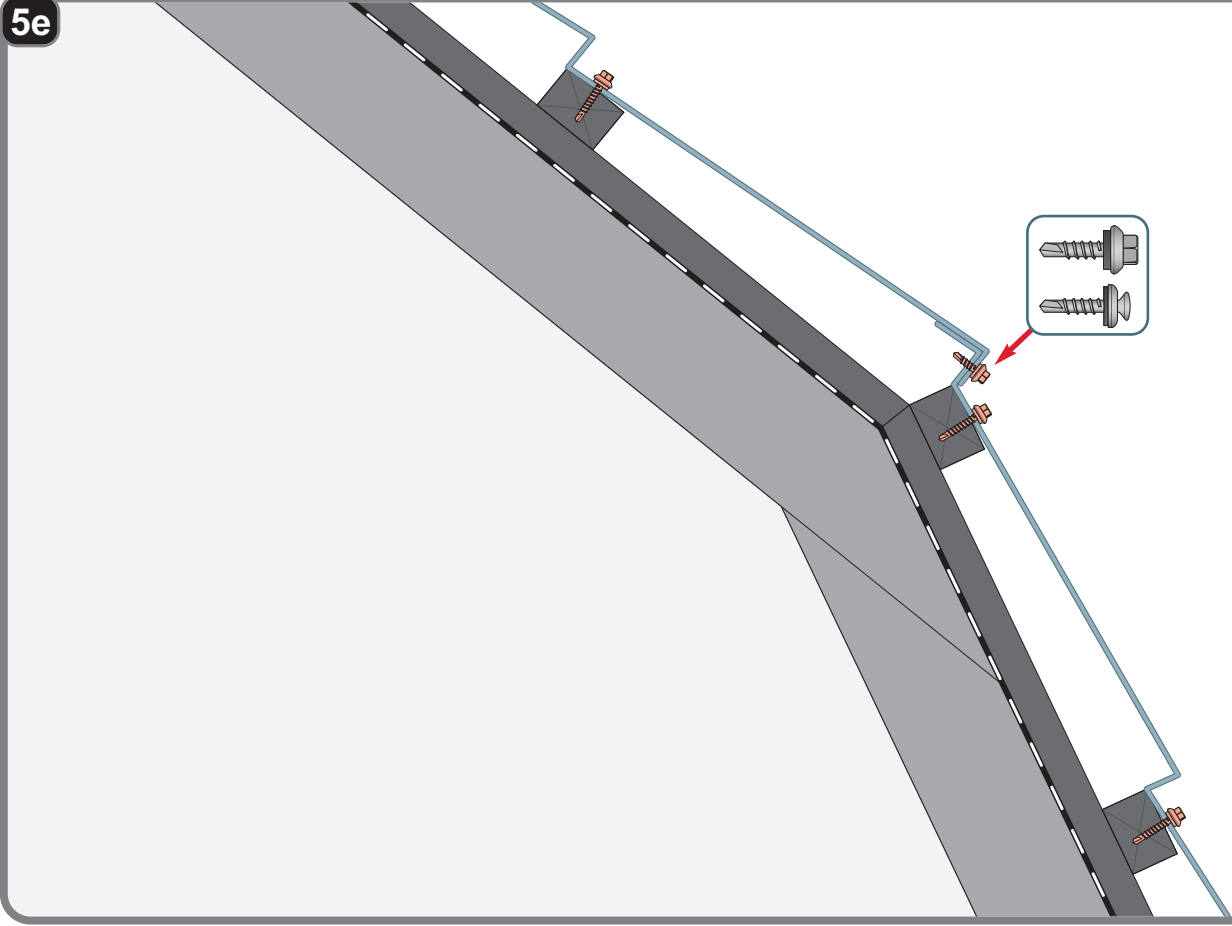
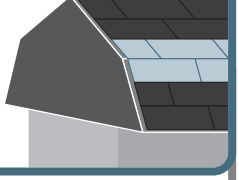

6a

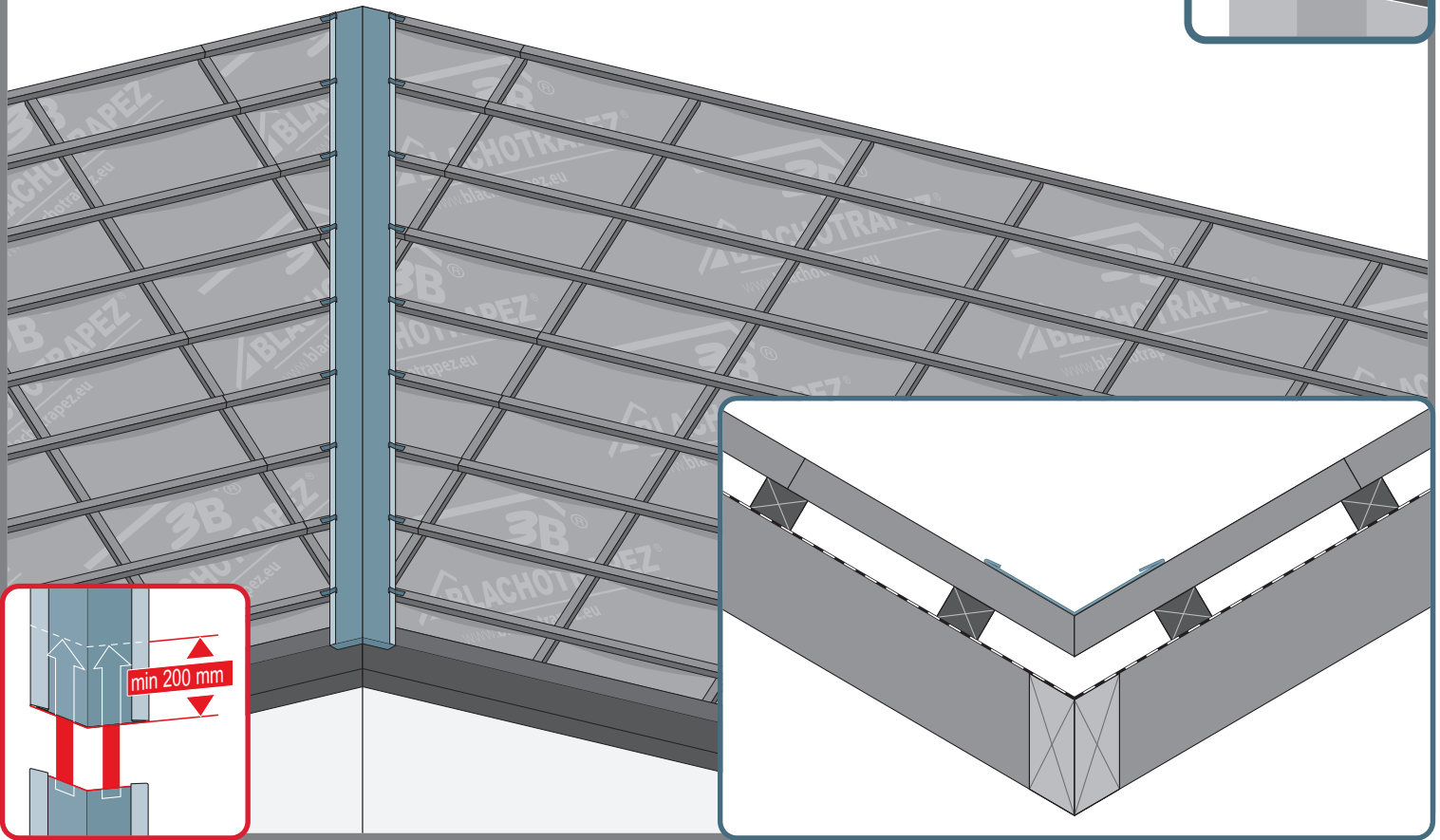

6b

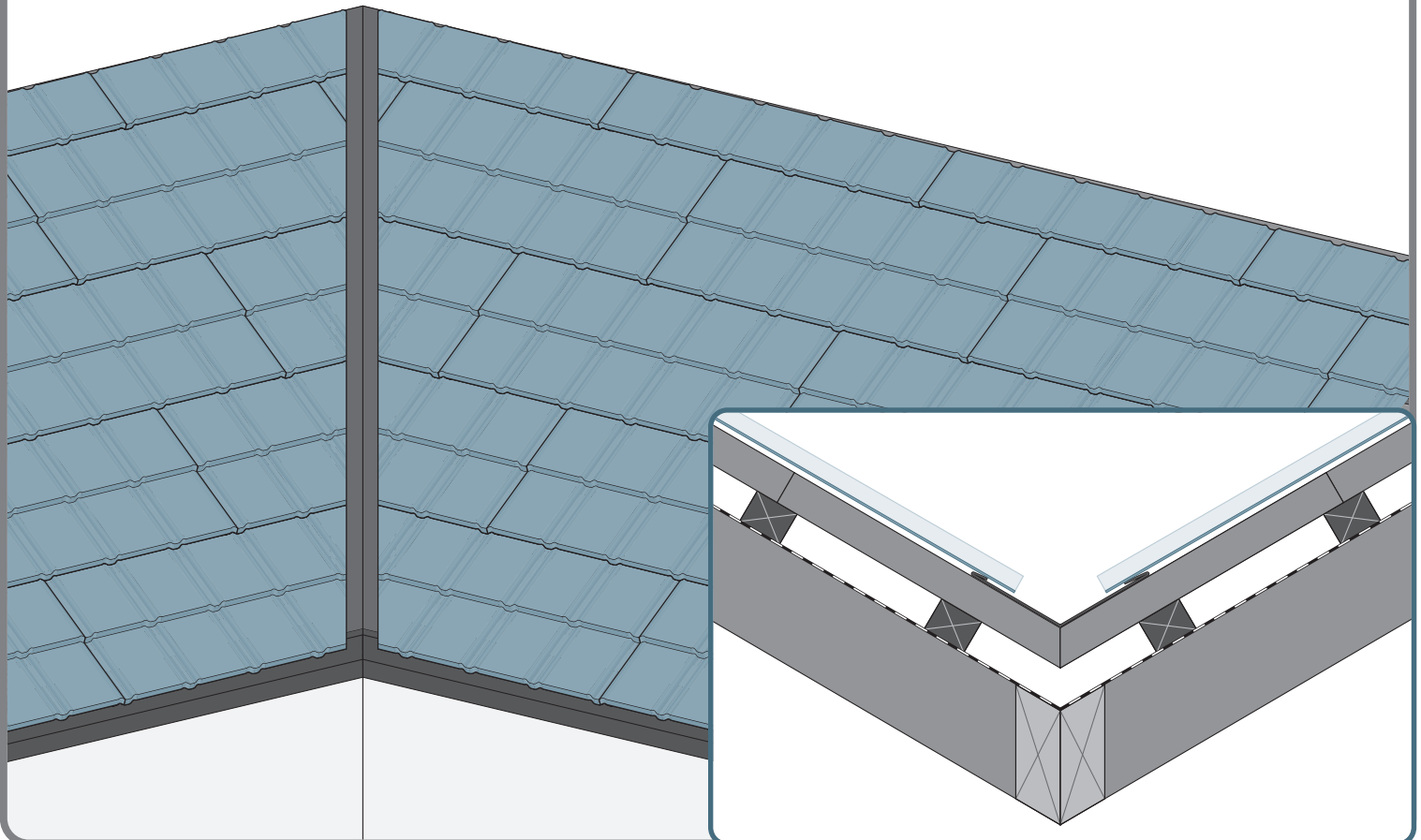

7a

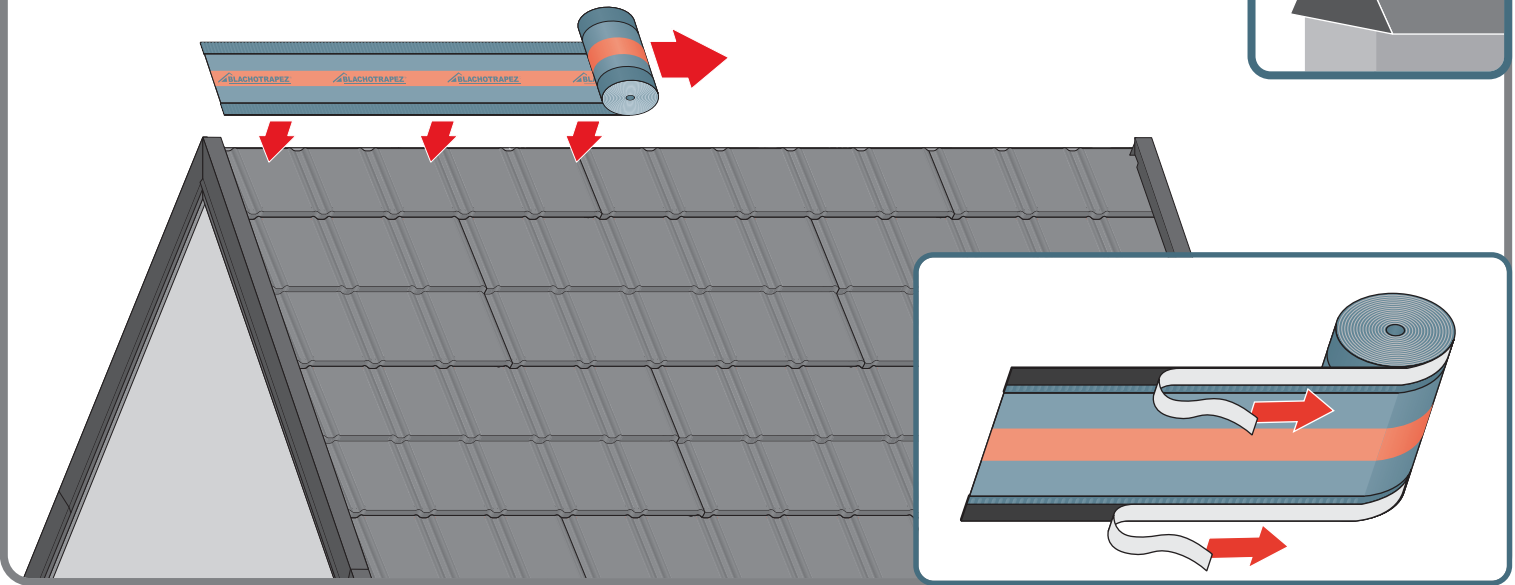

7b

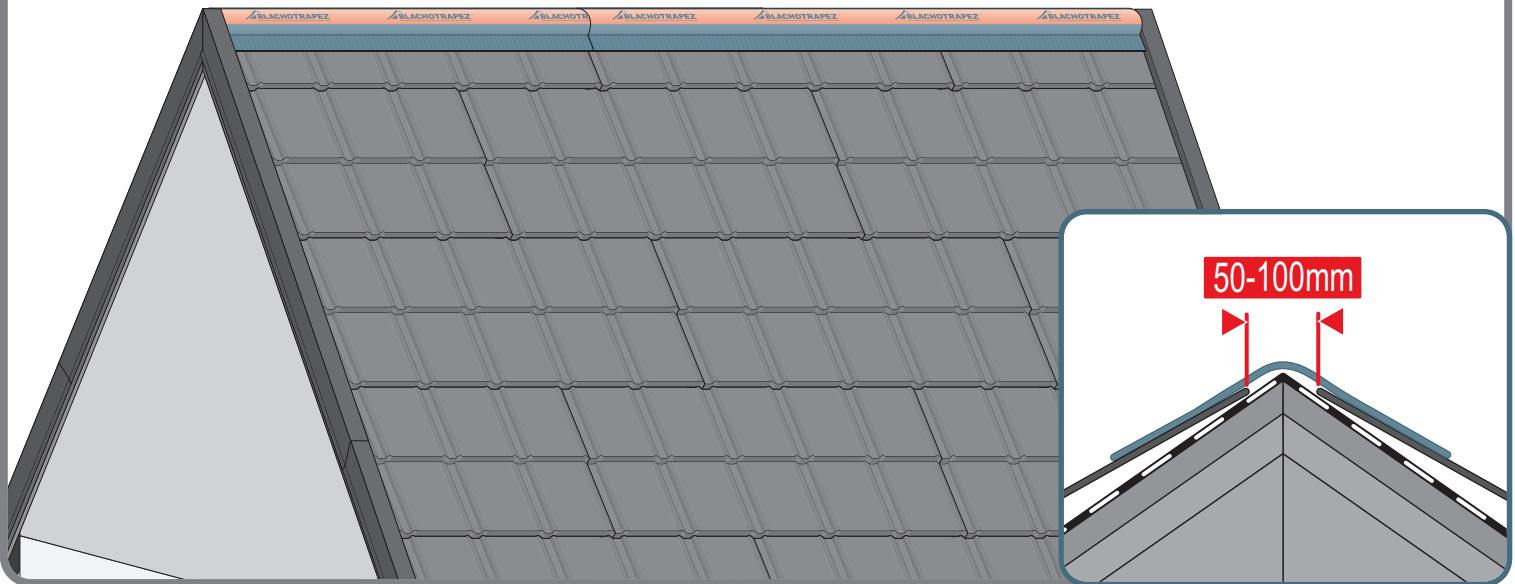

7c

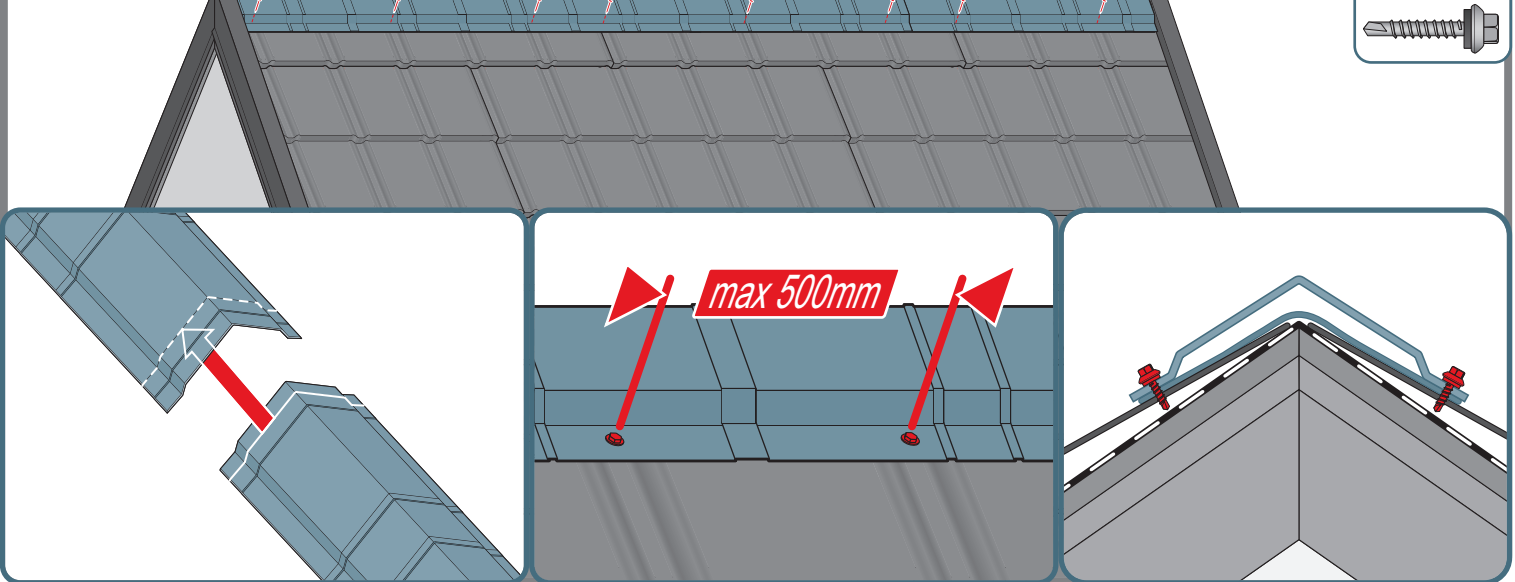

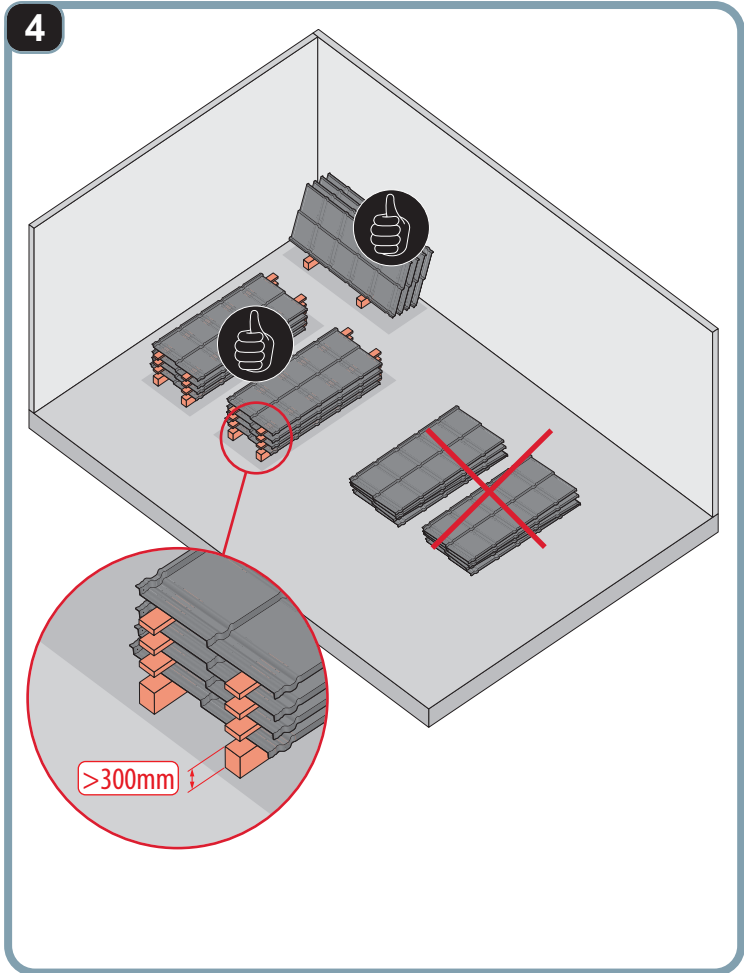
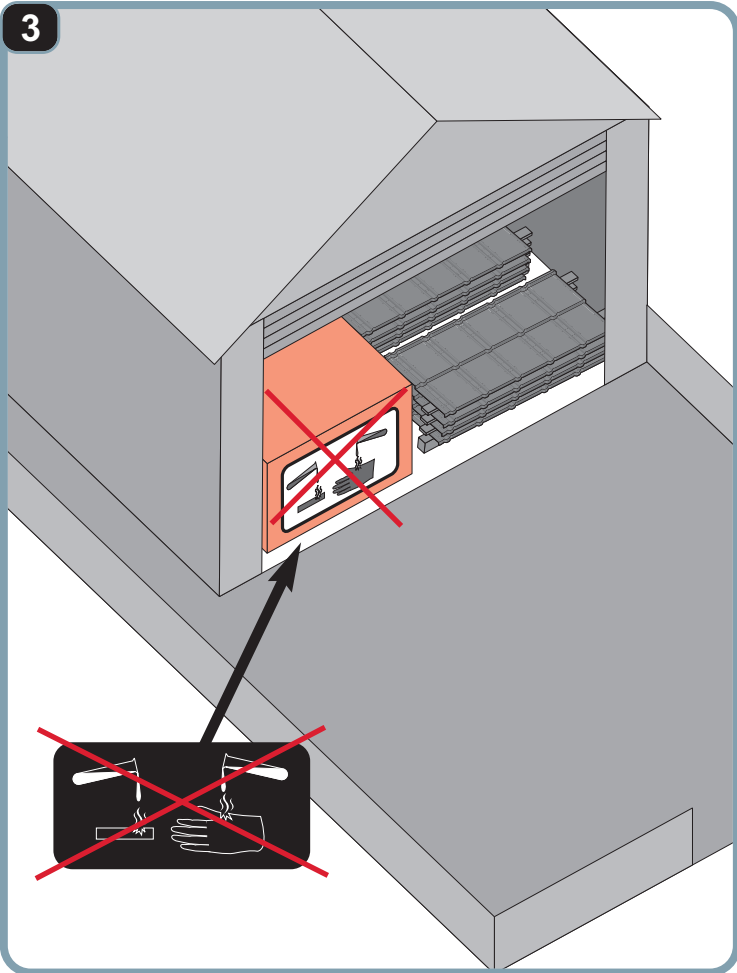
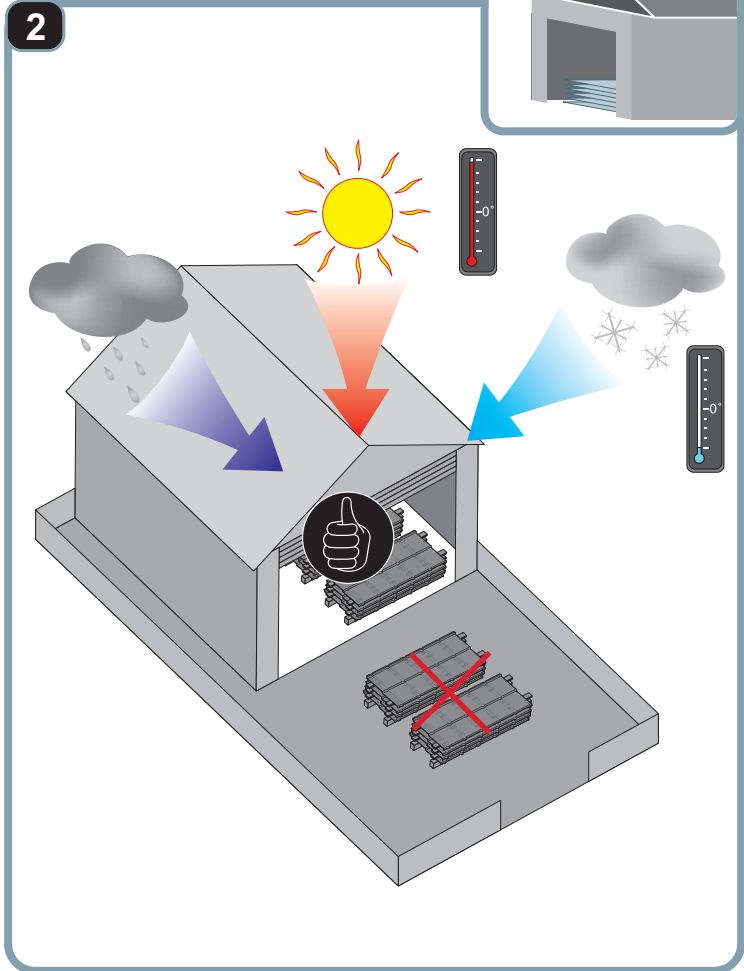
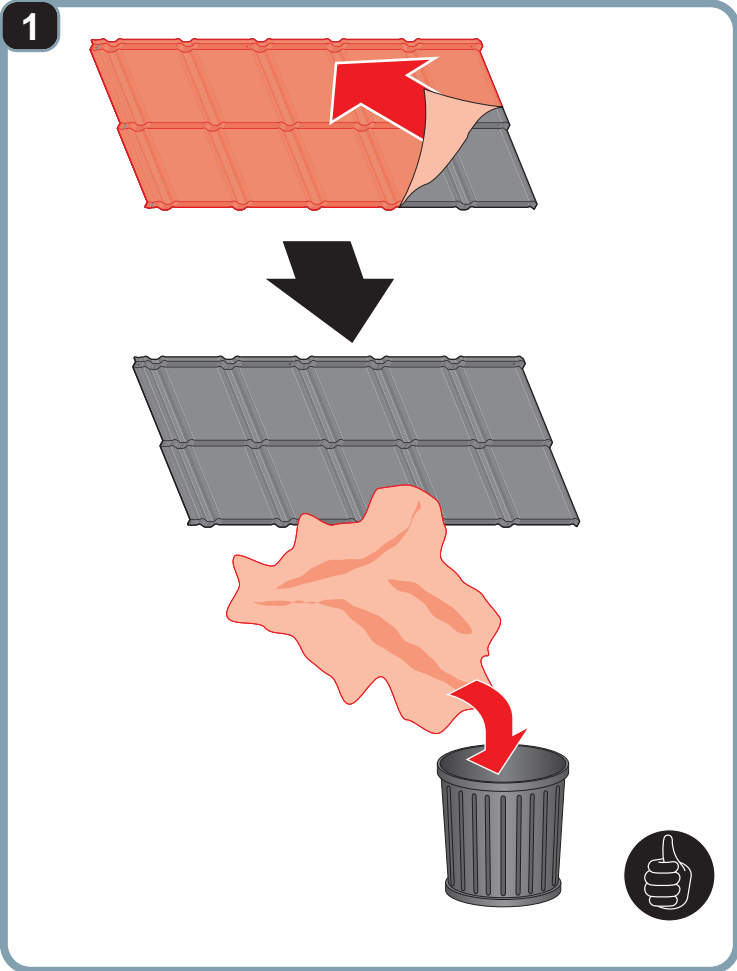





**BLACHOTRAPEZ Sp.z o.o.**  
**ul. Kilińskiego 49A**  
**34-700 RABKA ZDRÓJ, POLSKA**  
**tel. 18 26 85 200, fax. 18 26 85 215**  
**www. blachotrapez.eu**  
**blachotrapez@blachotrapez.eu**

1125

Metal roofing tiles are packed on pallets and secured with polyurethane foam, stretch film, and adhesive tape. Covers can be used for modular roofing tiles. Wooden pallets and other packaging elements protect goods during transport. The packaging method may vary for smaller orders (usually less than 20 meters) or depending on the country of distribution due to the specificity of the local market.

Before installation, carefully read the Data Sheet of the relevant Product, these Instructions and follow the installation procedures and the guidelines of the Occupational Safety and Health Administration (OSHA).

It is recommended that personal protective measures be taken when moving and carrying out work on the roof. These measures include, but are not limited to, fall protection equipment and personal protective equipment such as gloves, safety glasses, safety helmet and harness, etc. Avoid contact with sharp edges of sheet metal.

Sheet metal products are recyclable. Disposal should be made at a point of selective collection of waste at the end of the product's life cycle.

The installation of roofing sheets requires professional knowledge, specialist knowledge and experience. This manual is an illustrative material and does not release participants in the construction process and contractors from the obligation to comply with the principles of technical knowledge. The installation methods presented in this manual are general guidelines. The required installation method may differ from the one indicated in the manual depending on the type of roof or regional solutions. To use the general installation instructions and tips, follow the designer's guidelines or contact our technical support department. Experienced contractors have individual solutions that BLACHOTRAPEZ accepts.