

72079-00001.A

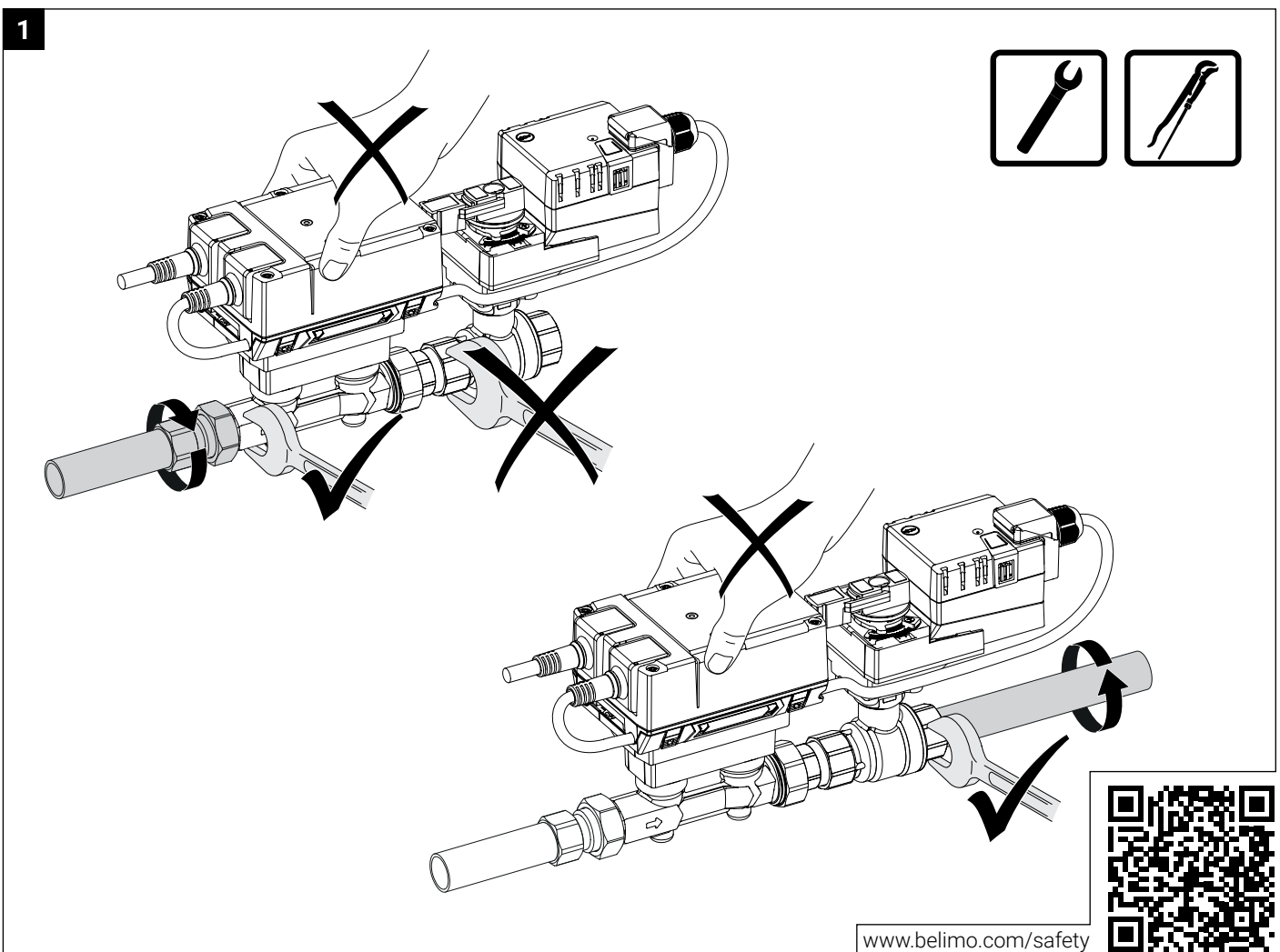

i

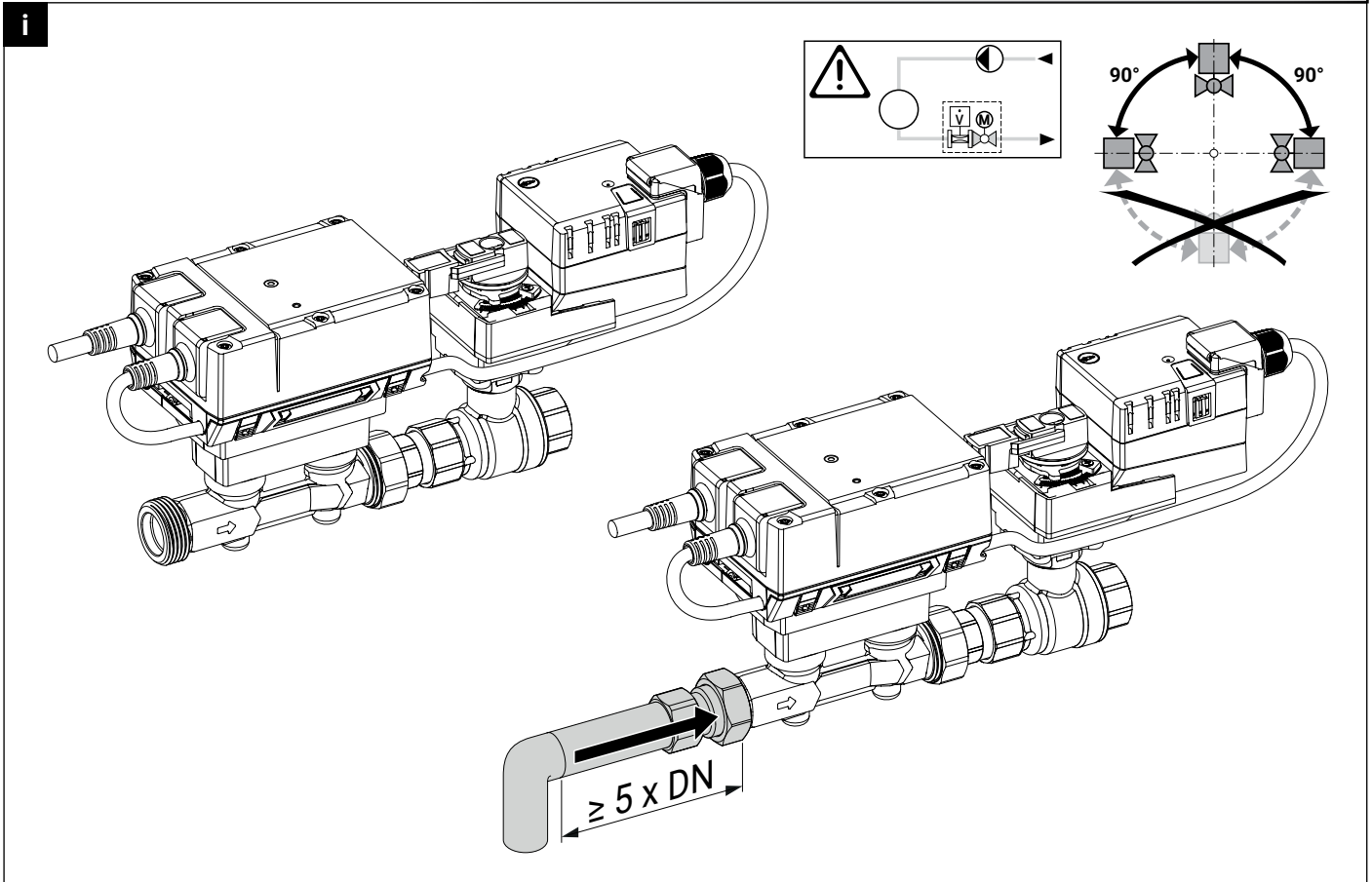
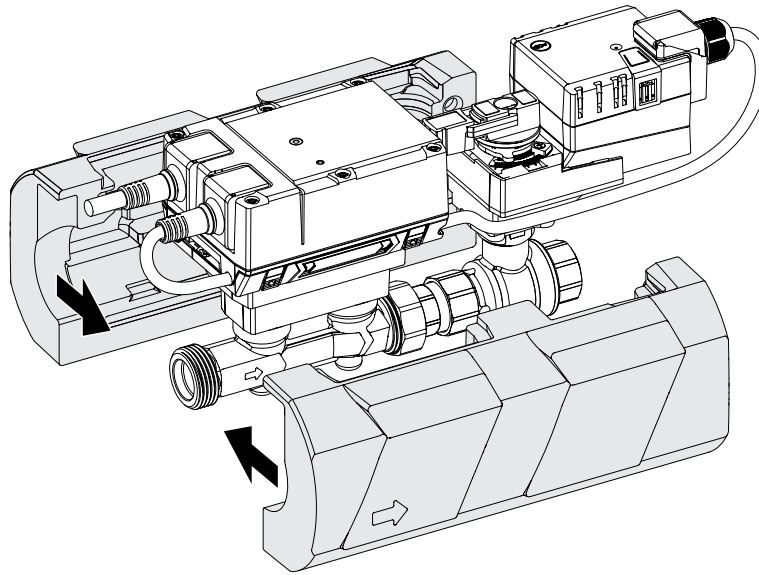

i optional

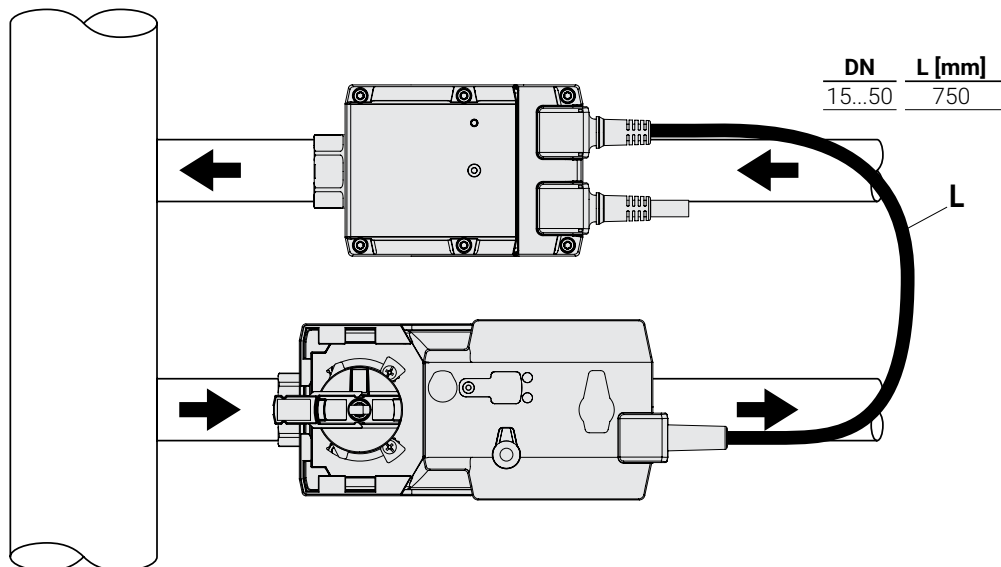

- 1 = GND
- 2 = AC/DC 24 V
- 3 = Sensor
- 5 = MP, 0...10 V
- 6 = C1 = D- = A
- 7 = C2 = D+ = B

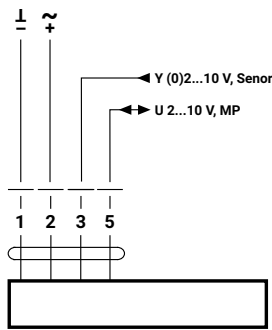

BACnet MSTP / Modbus RTU

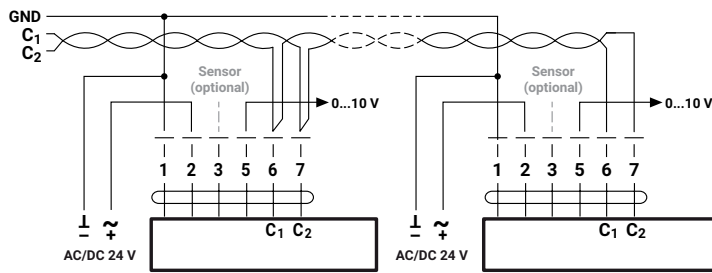

MP-Bus

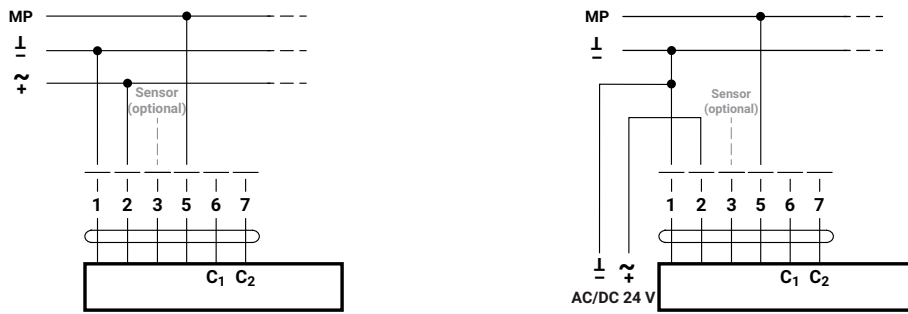

Sensor (optional)

